

JPEG

JPEG

- Joint Photographic Expert Group
- Voted as international standard in 1992
- Works with color and grayscale images, e.g., satellite, medical, ...
- **Motivation:** The compression ratio of lossless methods (e.g., Huffman, Arithmetic, LZW) is not high enough for image and video compression, especially when the distribution of pixel values is relatively flat.

Features

- Sequential encoding
 - Block-by-block encoding in scan order
- Progressive encoding
 - geared at progressive transmission, or successive approximations: to achieve higher order resolution pictures it uses more and more DCT coefficients, or more and more bits/coefficient
 - Note: Different quality resolutions are *not* available on the same bitstream
- Hierarchical encoding
 - A lower resolution image is encoded first, upsampled and interpolated to predict the full resolution and the prediction error is encoded with one of the other JPEG coders (pyramidal coder using the JPEG coder)
- Lossless encoding using a different strategy
 - Predictive coding on a neighborhood of three samples is used instead of DCT

Structure

- Block-based transform coding using DCT
- Rationale
 - Observation 1: A large majority of useful image contents change relatively slowly across images, i.e., it is unusual for intensity values to alter up and down several times in a small area, for example, within an 8 x 8 image block. Translate this into the spatial frequency domain, it says that, generally, lower spatial frequency components contain more information than the high frequency components which often correspond to less useful details and noises.
 - Observation 2: Psychophysical experiments suggest that humans are more receptive to loss of higher spatial frequency components than loss of lower frequency components.

Main steps

- Colorspace conversion
- DCT (Discrete Cosine Transformation)
- Quantization
- Zigzag Scan
- DPCM on DC component
 - DPCM: differential pulse code modulation
 - DC: zero-frequency component
- RLE on AC Components
 - Run Length Encoding
 - AC: other spectral components
- Entropy Coding

Block diagram

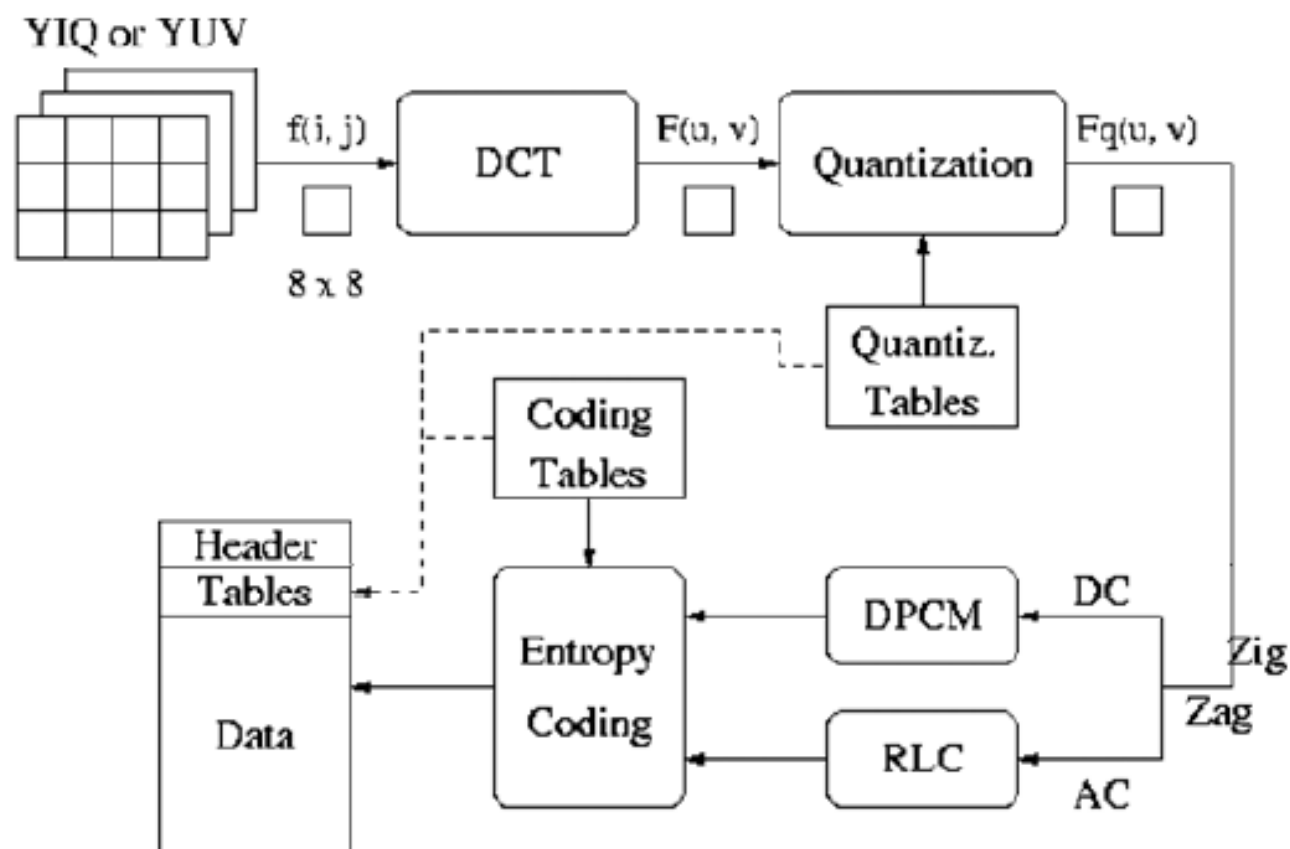

Color

- Images are converted from RGB to YCbCr
- Cb and Cr components are downsamples
 - Possible formats:
 - 4:4:4
 - 4:2:2
 - 4:2:0

$$\begin{aligned} Y &= 0.299 * R + 0.587 * G + 0.114 * B \\ Cb &= 128 - 0.168736 * R - 0.331264 * G + 0.5 * B \\ Cr &= 128 + 0.5 * R - 0.418688 * G - 0.081312 * B \end{aligned}$$

RGB

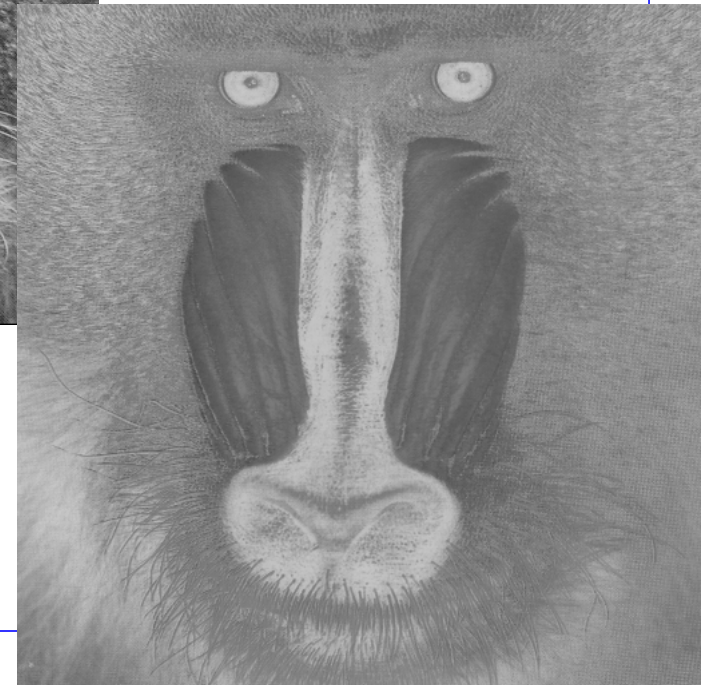
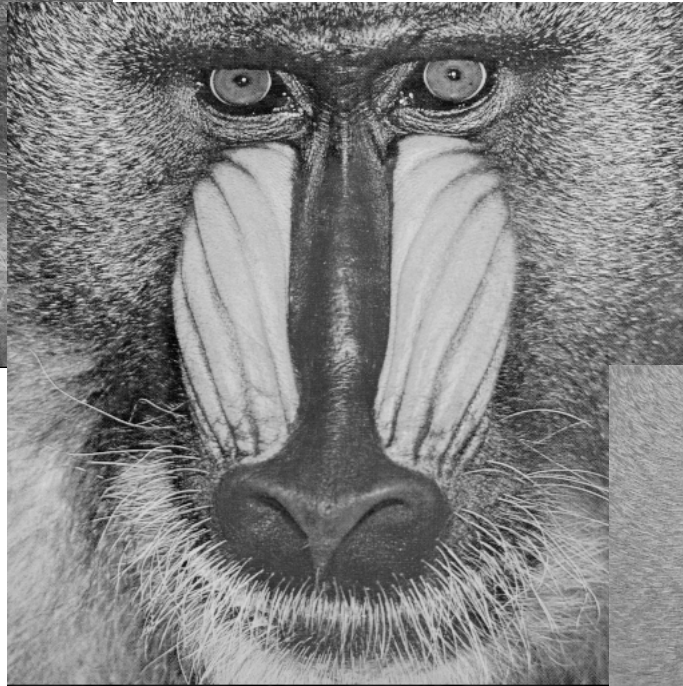
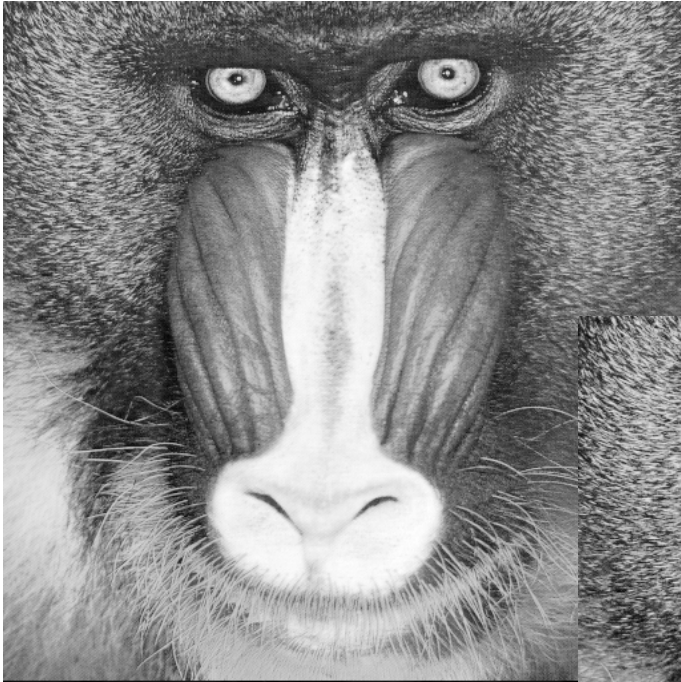

$\rho(\text{red-green})=0.3565$

ρ =correlation coefficient

$\rho(\text{green-blue})=0.85$

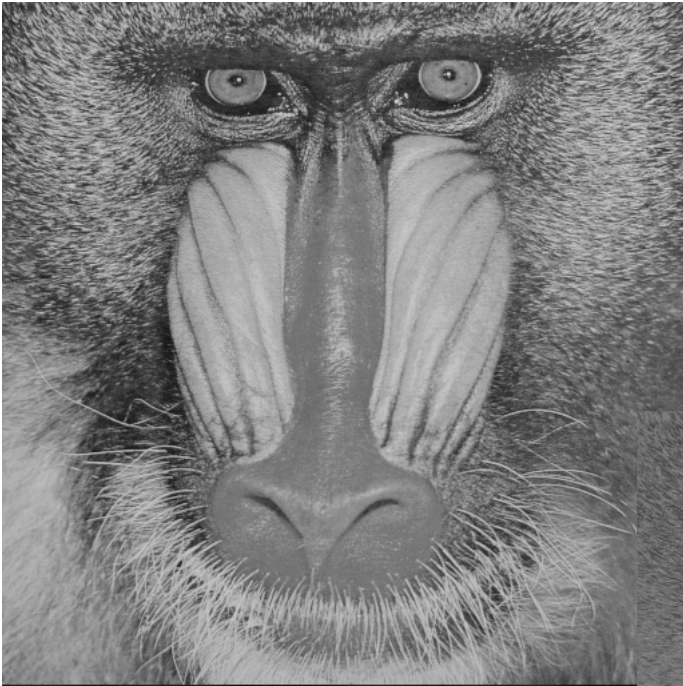

YCbCr

$\rho(YCb)=0.09$

ρ =correlation coefficient

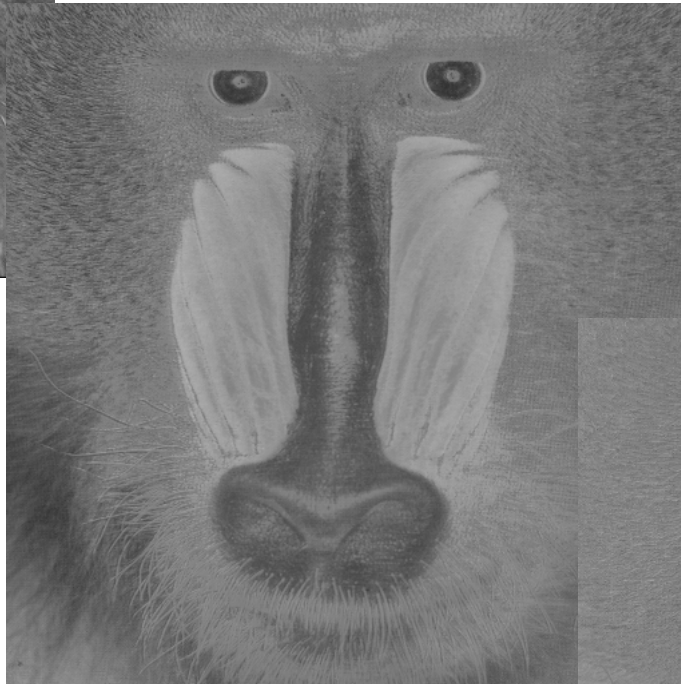

$\rho(YCr)=-0.1474$

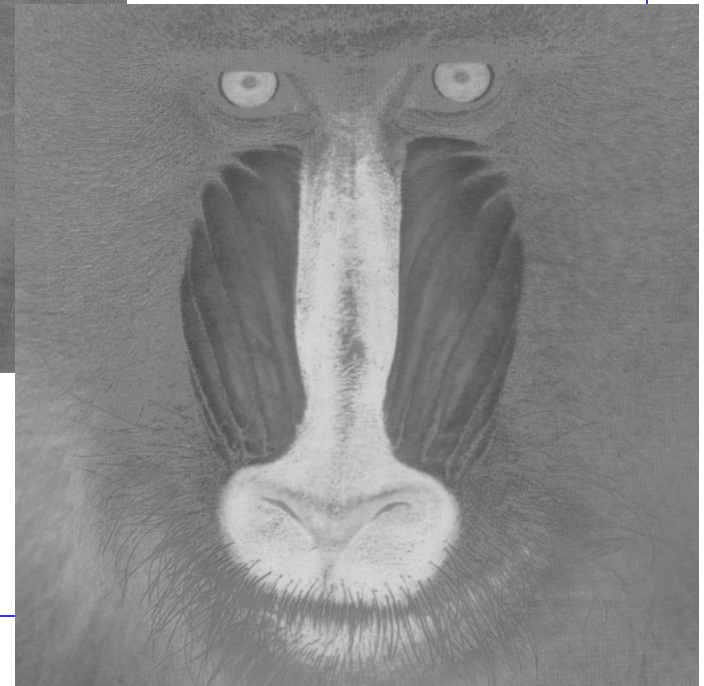

2D DCT

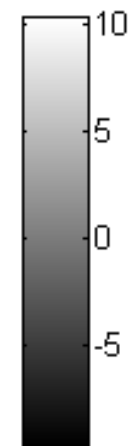
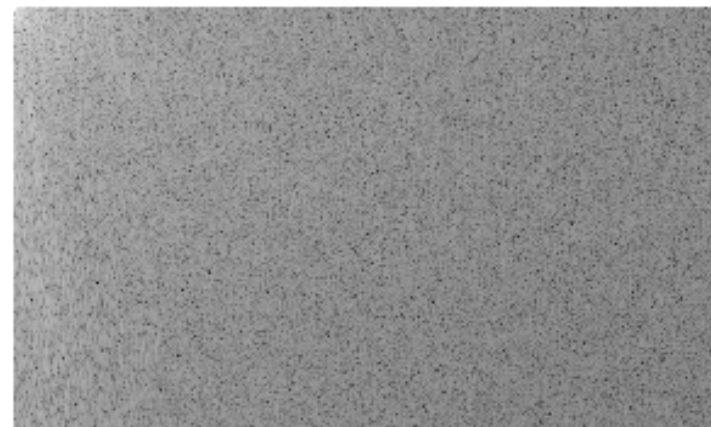

DCT: basis functions

Block-based transform

Block size $N=M=8$

This has proved to be a good compromise between coding efficiency (large blocks) and avoidance of blocking effects (small blocks).

This applies to typical target images: 512x512, target rate: 0.5bpp, bit depth=8 or 12 bits

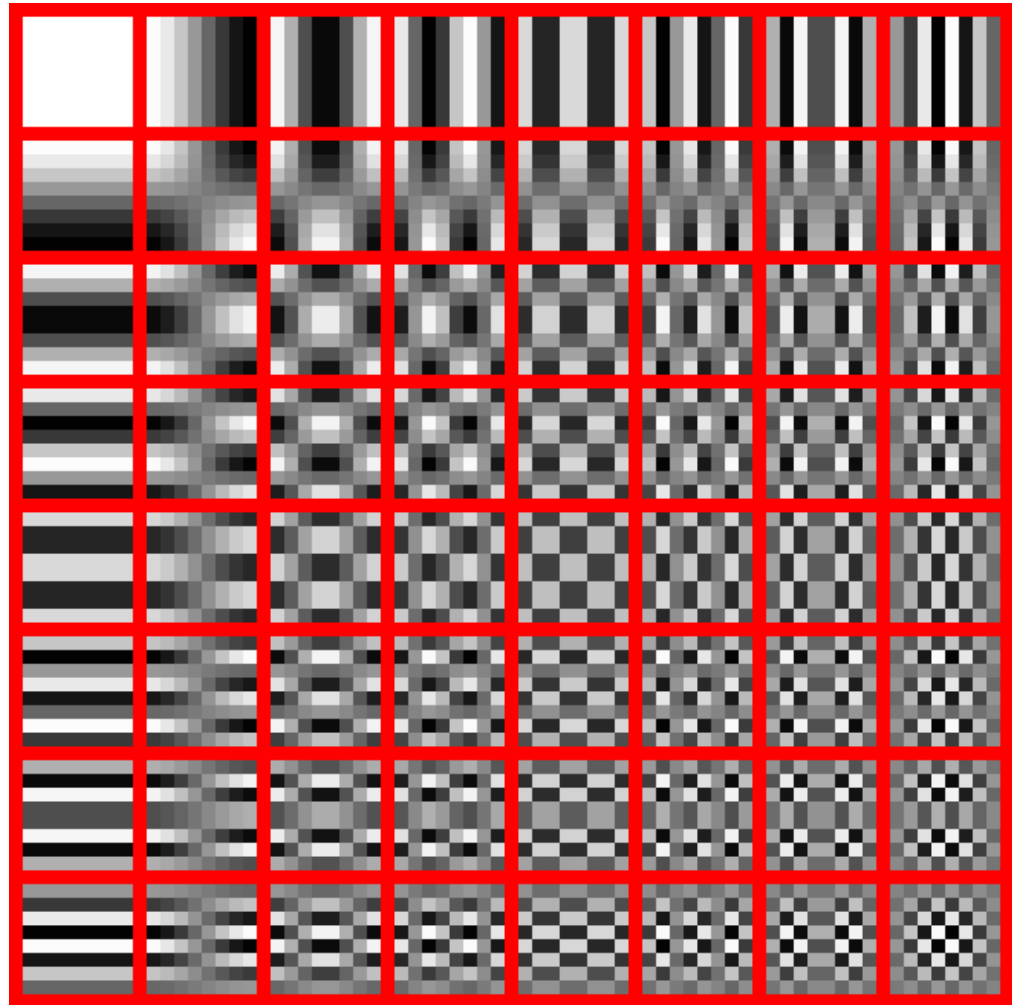

JPEG preview

Block-based DCT

Block size

$N=M=8$

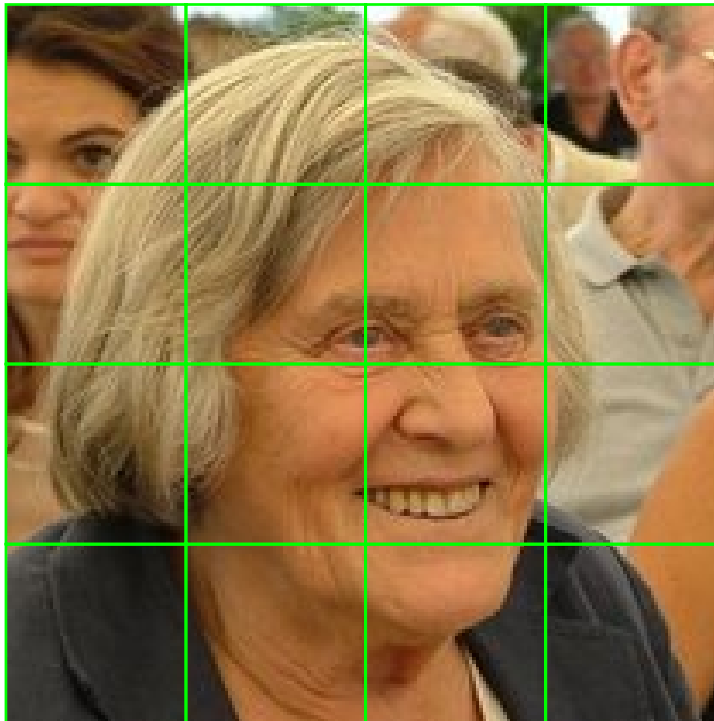

The source data (8x8) is transformed to a linear combination of these 64 frequency squares.

Block-based DCT

- The DCT coefficients are rounded to the nearest integer and 128 is subtracted. Then they are divided by the corresponding weight in the quantization matrix (see quantization)

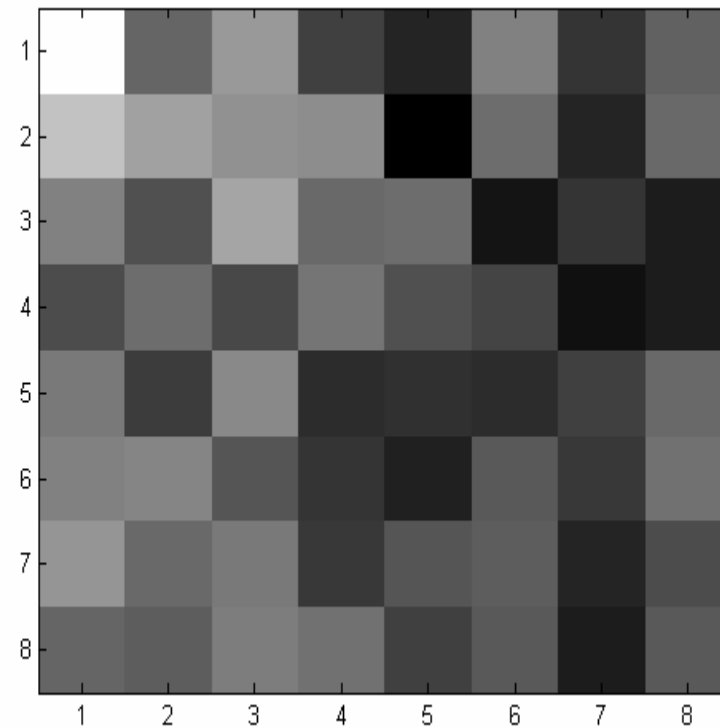
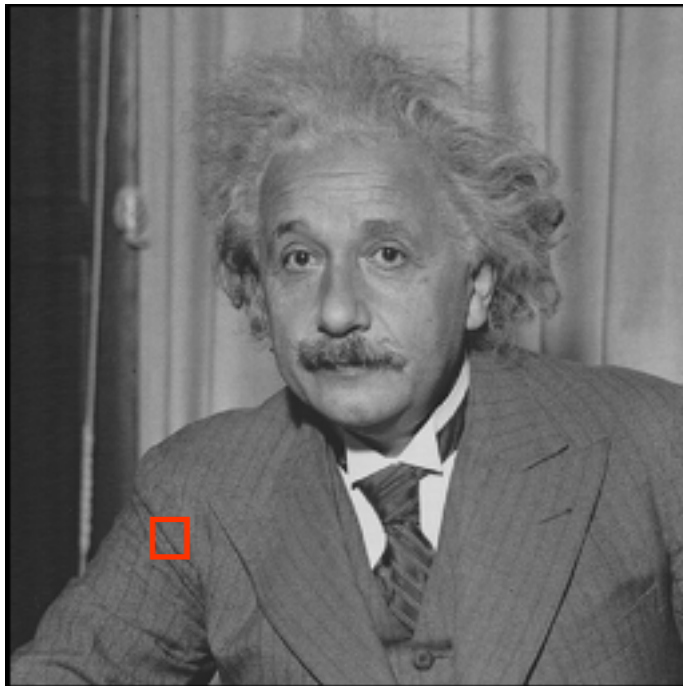

Quantization

- JPEG quantizes the block cosine coefficients uniformly

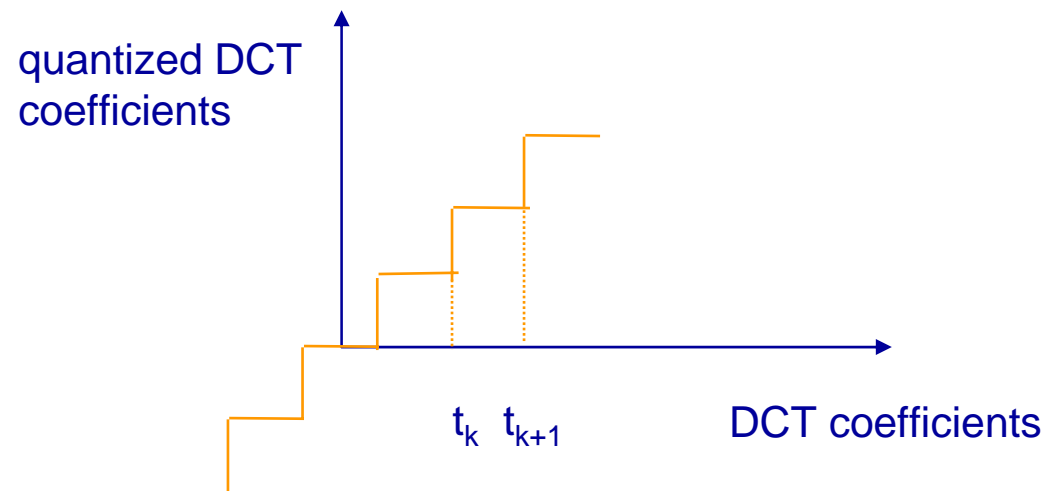

Weighted quantization qui

- “Perceptual” quantization is also possible
 - Based on the observation that the human eye is more sensible to low than to high frequencies (luminance and color CSF)
 - The quantization tables are given but the standard allows the user to define his own quantization tables
 - quantization interval \propto wights

Luminance

```
-----  
16 11 10 16 24 40 51 61  
12 12 14 19 26 58 60 55  
14 13 16 24 40 57 69 56  
14 17 22 29 51 87 80 62  
18 22 37 56 68 109 103 77  
24 35 55 64 81 104 113 92  
49 64 78 87 103 121 120 101  
72 92 95 98 112 100 103 99  
-----
```

Chromaticity

```
-----  
17 18 24 47 99 99 99 99  
18 21 26 66 99 99 99 99  
24 26 56 99 99 99 99 99  
47 66 99 99 99 99 99 99  
99 99 99 99 99 99 99 99  
99 99 99 99 99 99 99 99  
99 99 99 99 99 99 99 99  
99 99 99 99 99 99 99 99  
-----
```

Contrast sensitivity function (CSF)

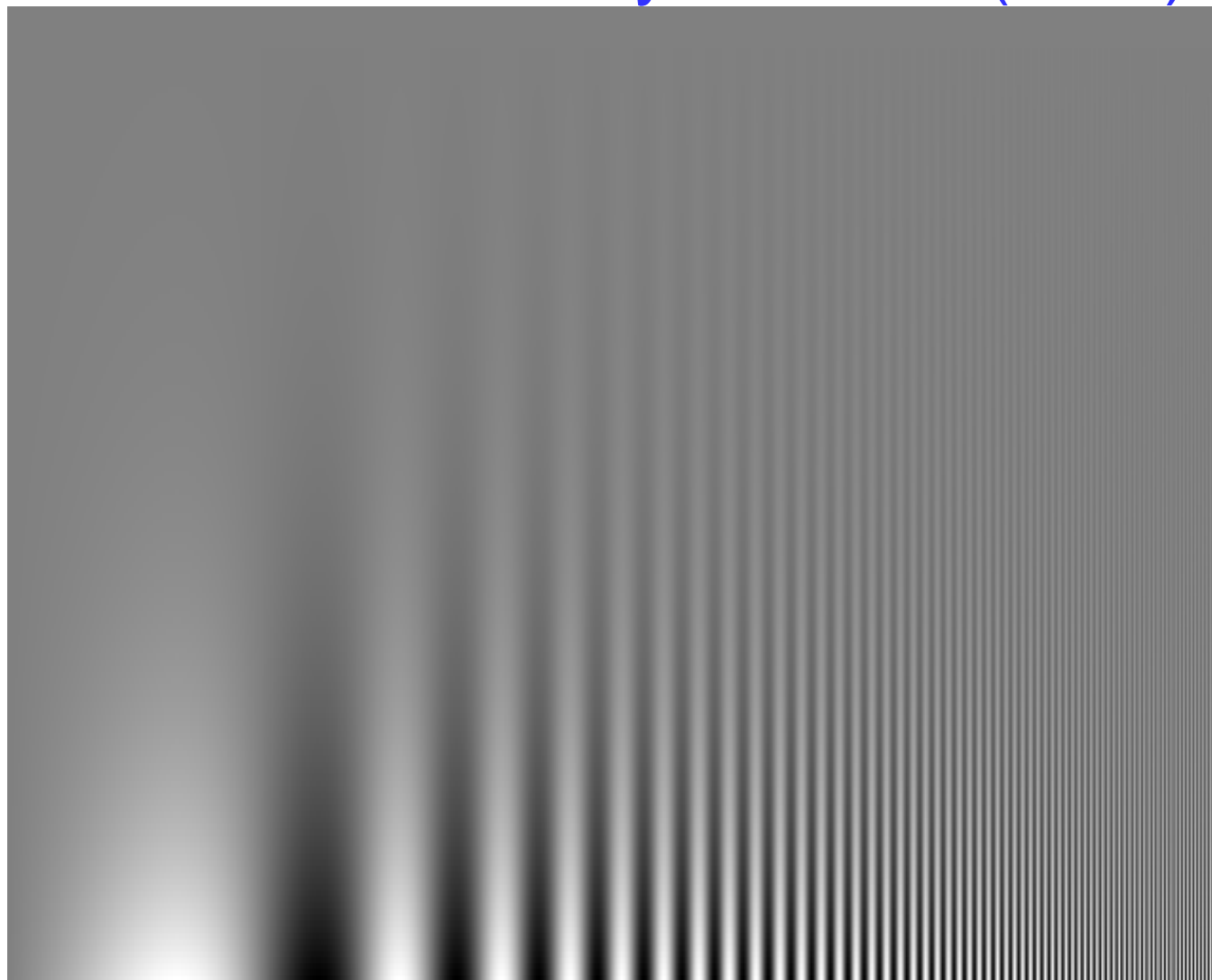

Luminance and Chromatic CSF

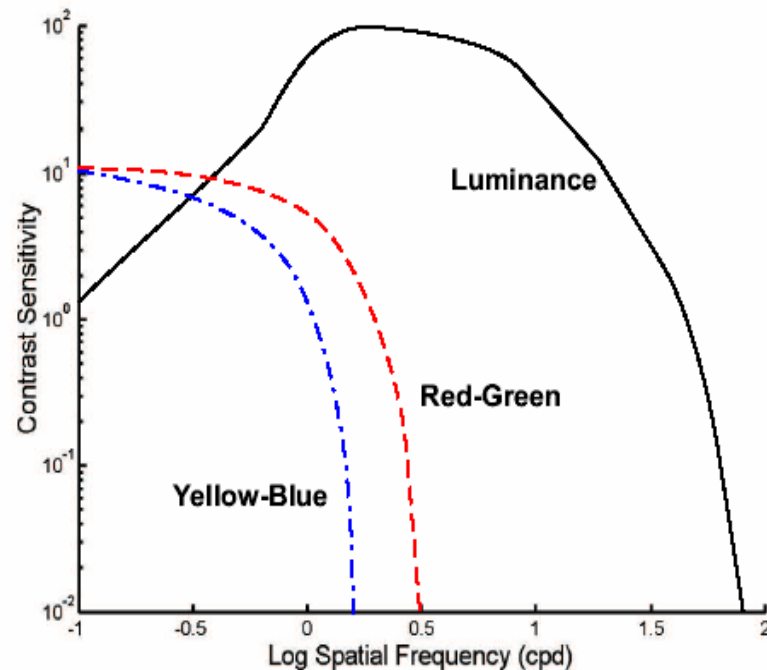

The spatial CSF for luminance contrast is band-pass in nature, with a **peak sensitivity around 5 cycles per degree**. This function approaches zero at zero cycles per degree, illustrating the tendency for the visual system to be insensitive to uniform fields. It also **approaches zero at about 60 cycles per degree**, the point at which details can no longer be resolved by the human eye.

The chromatic mechanisms are of a low-pass nature and have **significantly lower cut-off frequencies**. This indicates the reduced availability of chromatic information for the details.

The yellow-blue CSF has a lower cutoff frequency than the red-green one.

Note also that the **luminance CSF is much higher** than the chromatic CSFs. This denotes a **greater sensitivity of the visual system to small changes in luminance contrast compared to chromatic contrast**.

Raster scan of the coefficients

- In each block the coefficients are scanned in zig-zag order, which groups similar frequencies

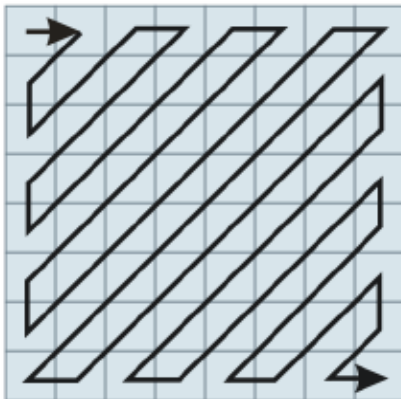

quantized DCT coefficients

$$\begin{bmatrix} -26 & -3 & -6 & 2 & 2 & -1 & 0 & 0 \\ 0 & -2 & -4 & 1 & 1 & 0 & 0 & 0 \\ -3 & 1 & 5 & -1 & -1 & 0 & 0 & 0 \\ -3 & 1 & 2 & 0 & 0 & 0 & 0 & 0 \\ 1 & 0 & 0 & 0 & 0 & 0 & 0 & 0 \\ 0 & 0 & 0 & 0 & 0 & 0 & 0 & 0 \\ 0 & 0 & 0 & 0 & 0 & 0 & 0 & 0 \\ 0 & 0 & 0 & 0 & 0 & 0 & 0 & 0 \end{bmatrix}$$

```
-26,  
-3, 0,  
-3, -2, -6,  
2, -4, 1, -3,  
1, 1, 5, 1, 2,  
-1, 1, -1, 2, 0, 0,  
0, 0, 0, 0, -1, 0, 0,  
0, 0, 0, 0, 0, 0, 0, 0, 0, 0, 0, 0, 0, 0, 0, 0, 0,  
0, 0, 0, 0, 0, 0, 0, 0, 0, 0, 0, 0, 0, 0, 0, 0, 0
```

DPCM on DC component

- The DC component changes slowly across the image
 - Since the bit depth is 8, it can be shown that the DCT coefficients are in the range $[-2^{10}, 2^{10}-1]$
- The residual with respect to the previous block is bounded

$$DC^i - DC^{i-1} \in [-2^{11}, 2^{11} - 1]$$

DCⁱ⁻¹ block i-1

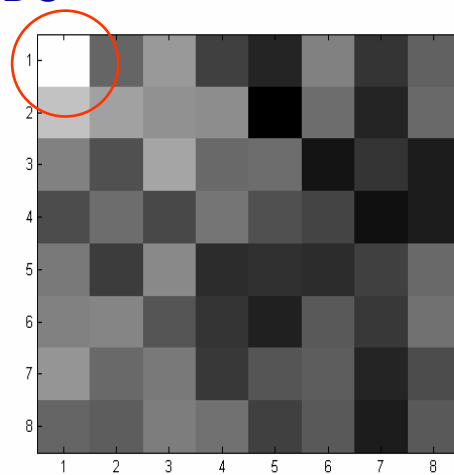

DCⁱ block i

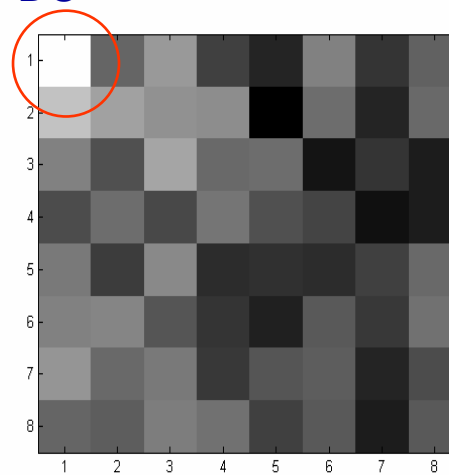

DPCM

- Predictive coding: The difference between the actual sample value and its predicted value (predicted value is based on previous sample or samples) is quantized and then encoded forming a digital value.
 - DPCM code words represent differences between samples unlike PCM where code words represented a sample value.
- Based on the fact that most source signals show significant correlation between successive samples so encoding uses redundancy in sample values which implies lower bit rate.
- Realization of basic concept
 - Predict current sample value based upon previous samples (or sample) and encode the difference between actual value of sample and predicted value (the difference between samples can be interpreted as prediction error).

JPEG codeblock

- Succession of symbols $S1=(L,B)$ of eight bits followed by symbol $S2$
 - L: length of a consecutive run of zeros, coded on 4 bits
 - It takes values between 0 and 15
 - B: number of bits used to code the value of the next non-zero coefficient
 - The symbol $S1=(15,0)$ is interpreted as a run-length of size 16 followed by another run length
 - Usually more than 15 zeros are present
 - If B is not zero, the subsequent symbol (of size B bits) specifies the amplitude of the next non zero coefficient

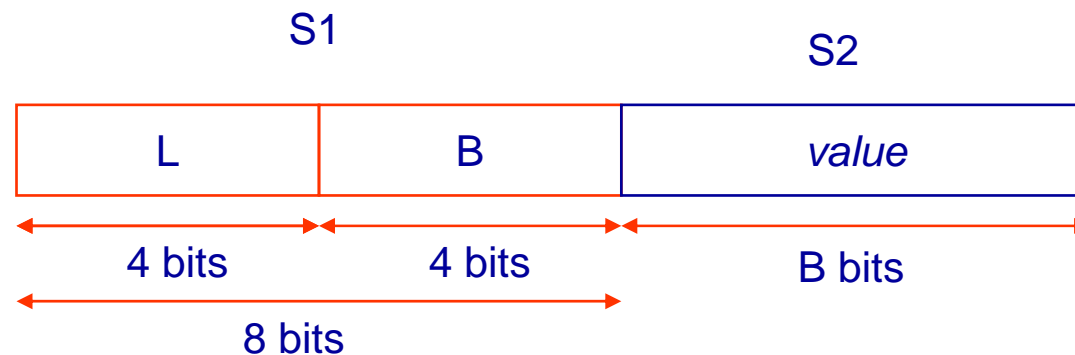

Example

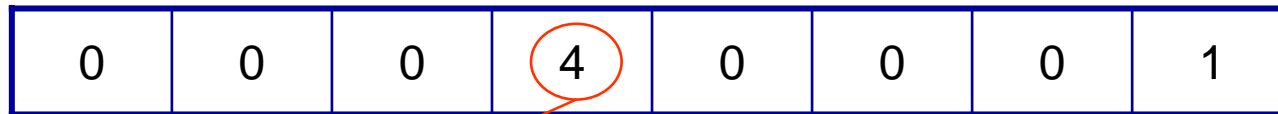

(3,3)(100)(3,1)(1)

LB
S1 S2

The value of the coefficient coded on B bits belongs to a set of 2^B values as indicated in the second column

B	Range of values
1	-1 1
2	-3 -2 2 3
3	-7 ... -4 4 ... 7
4	-15 ... -8 8 ... 15
.....
10	-1023 ... -512 512 ... 1023

Example

0.2bpp

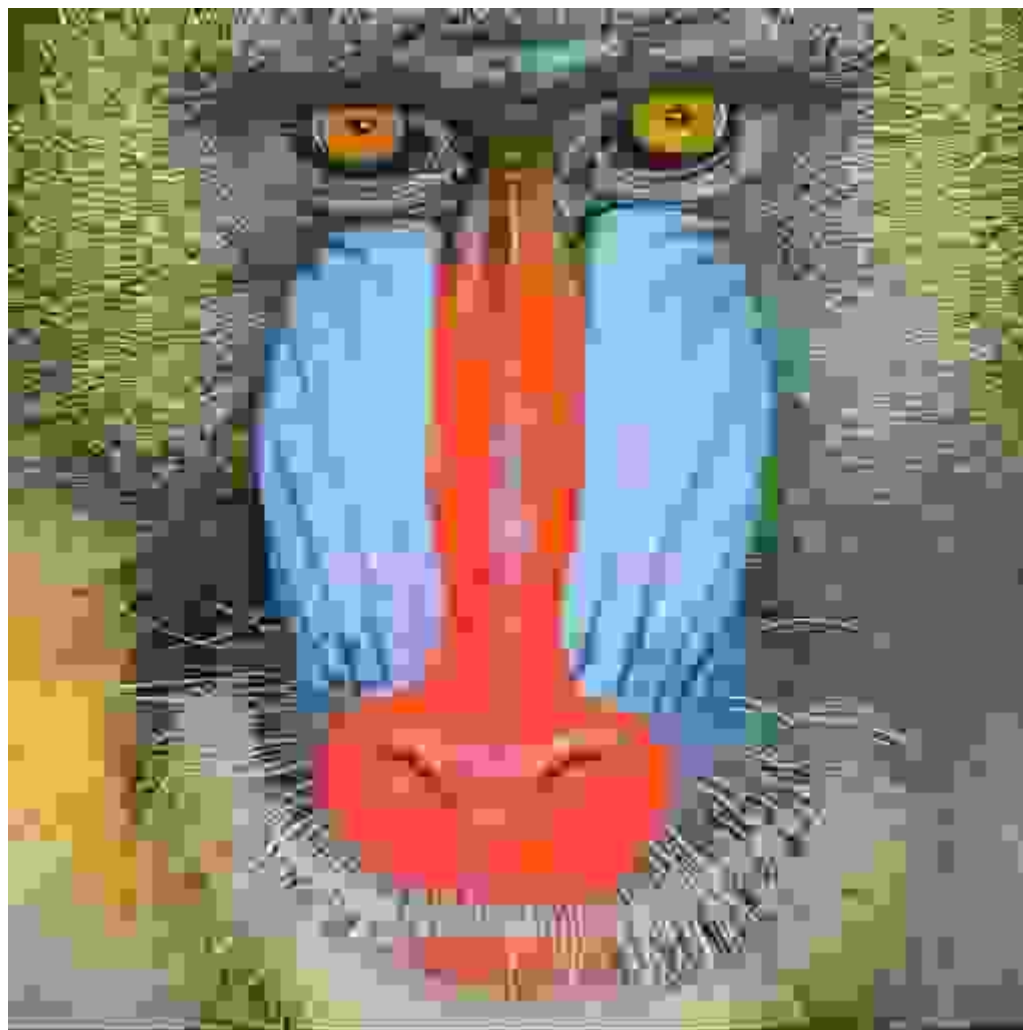
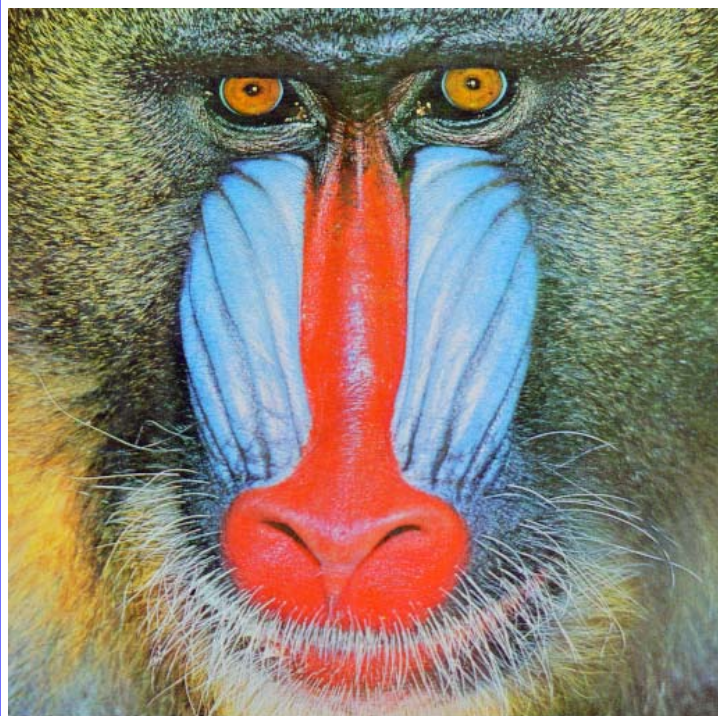

Example

0.5bpp

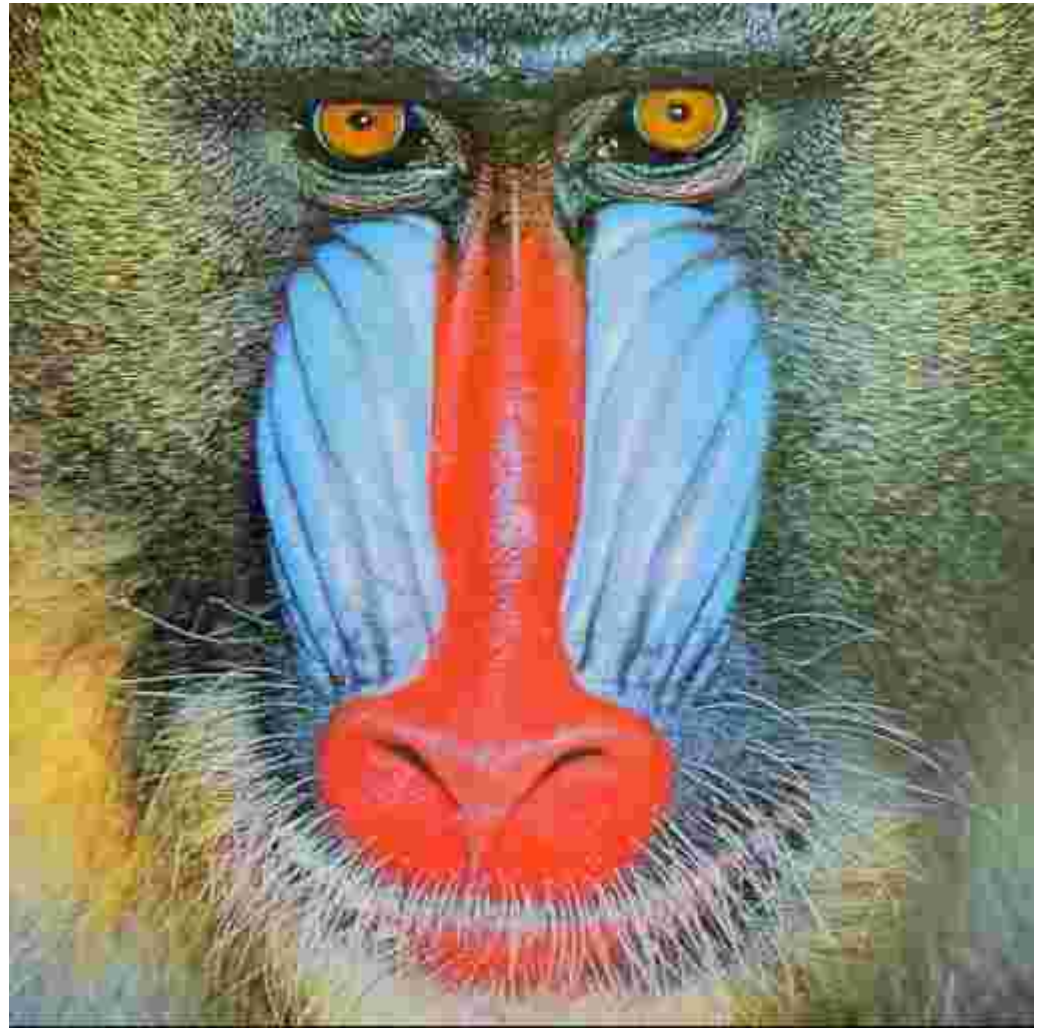
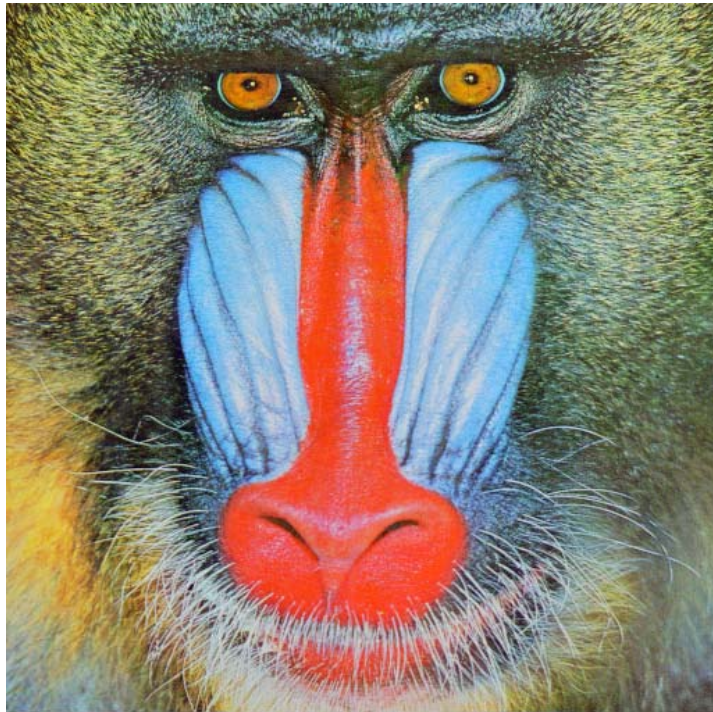

Example

0.97bpp

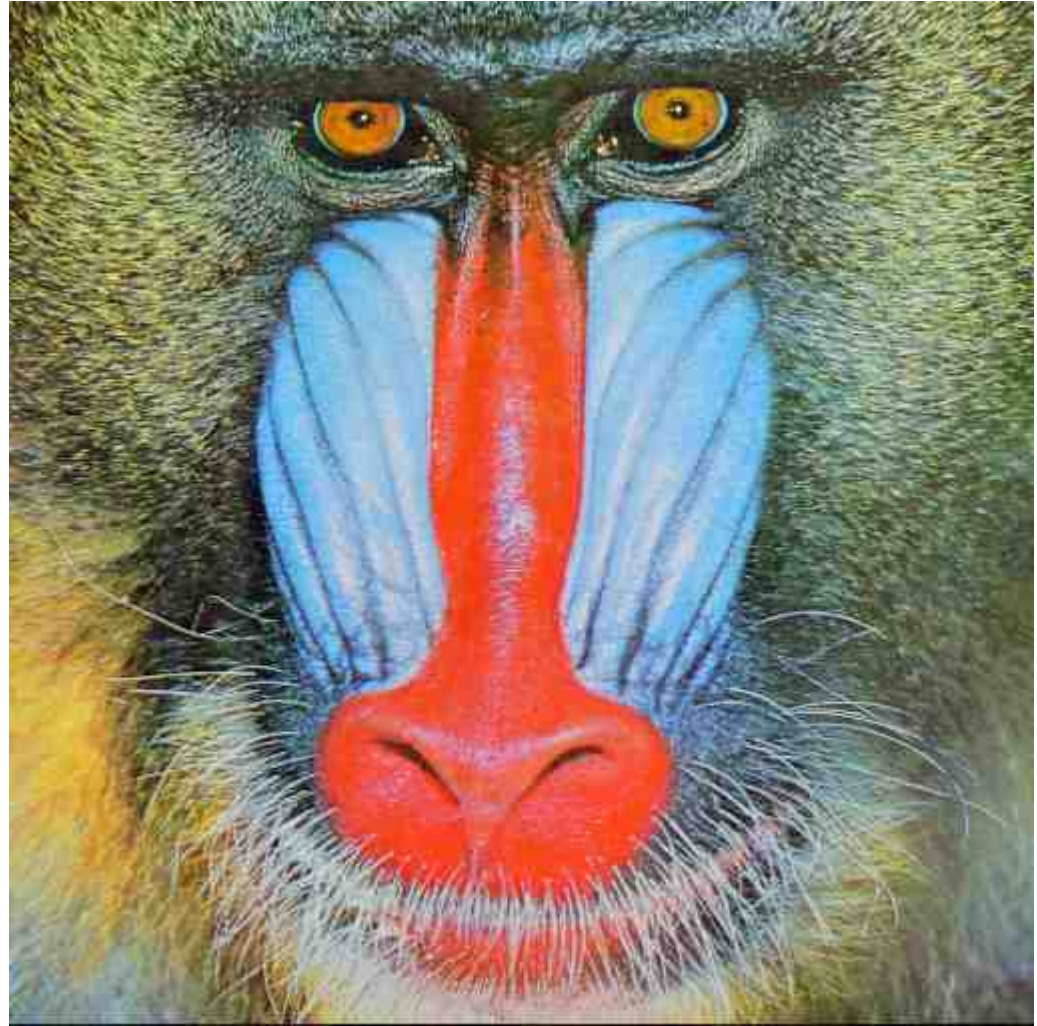

Example

1.5bpp

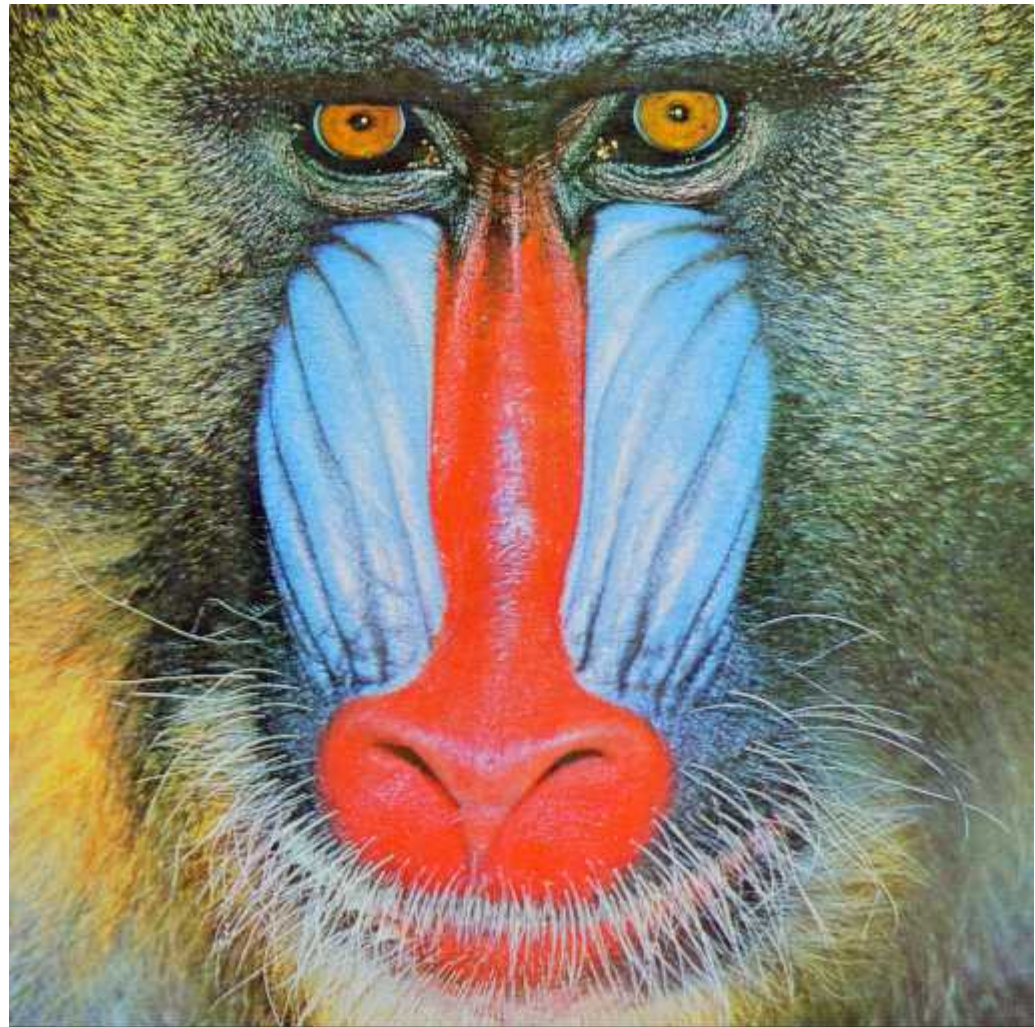
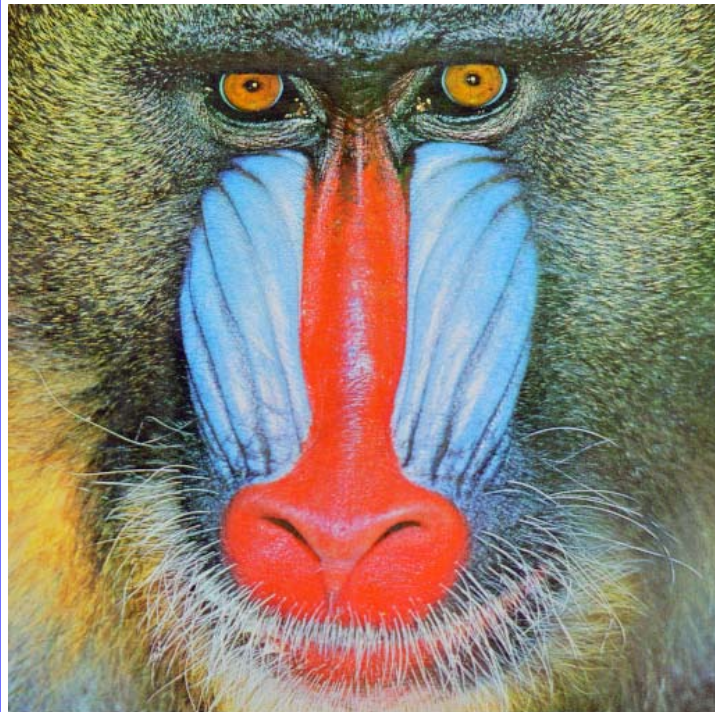

Example

2.5bpp

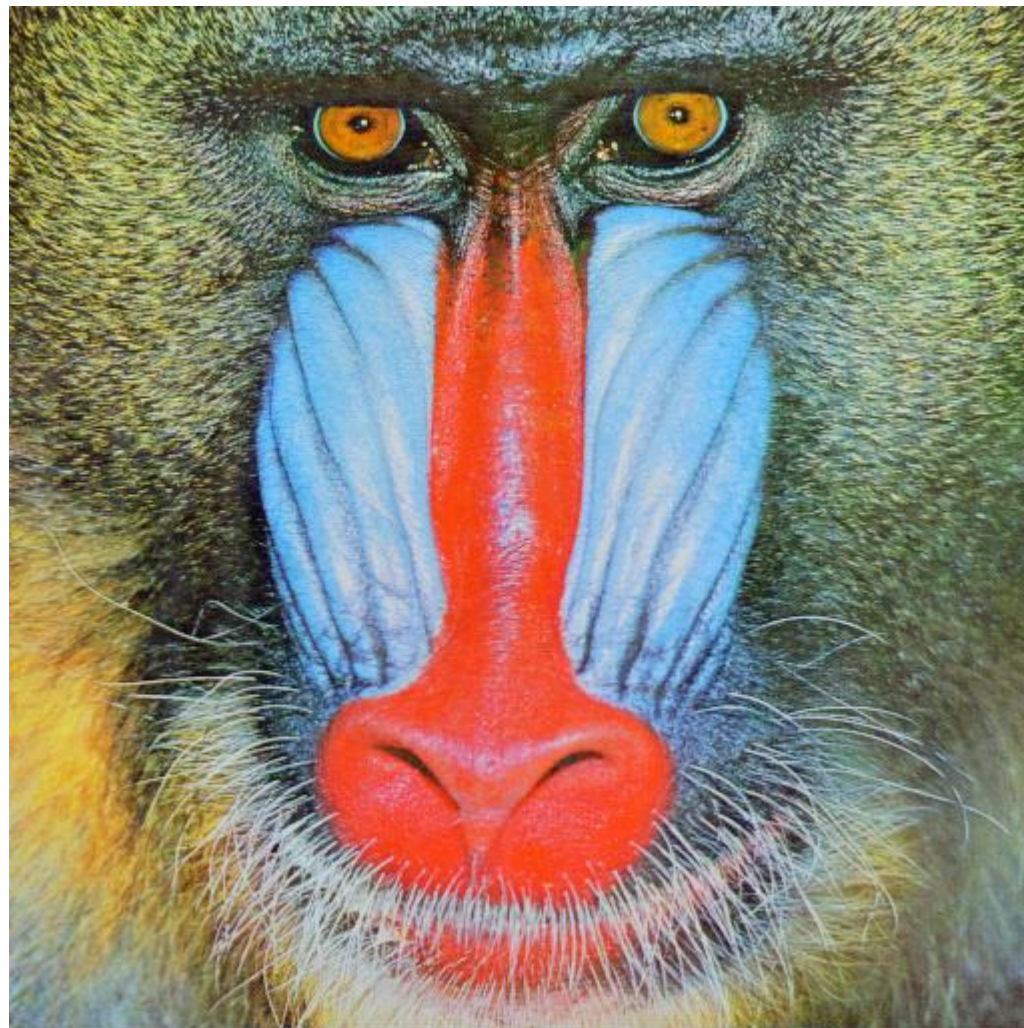
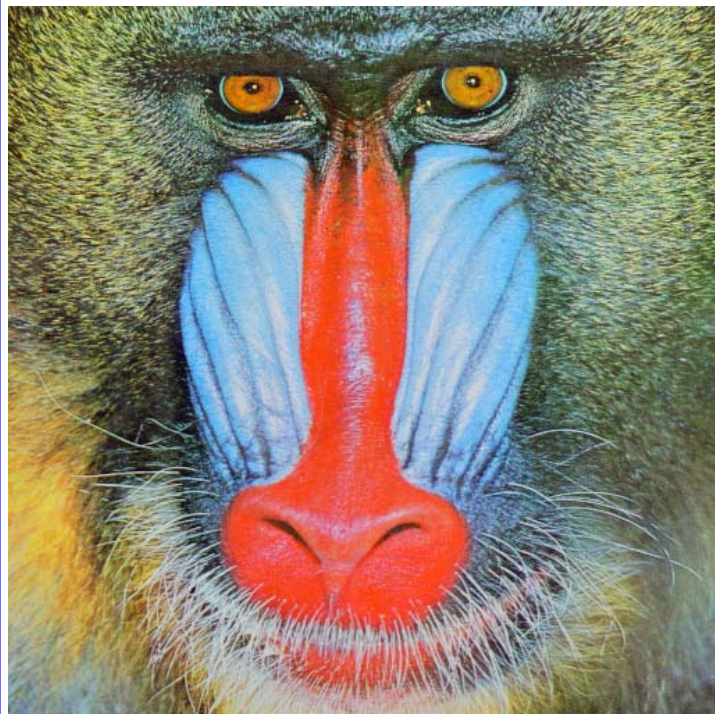

Rate/Distortion plot

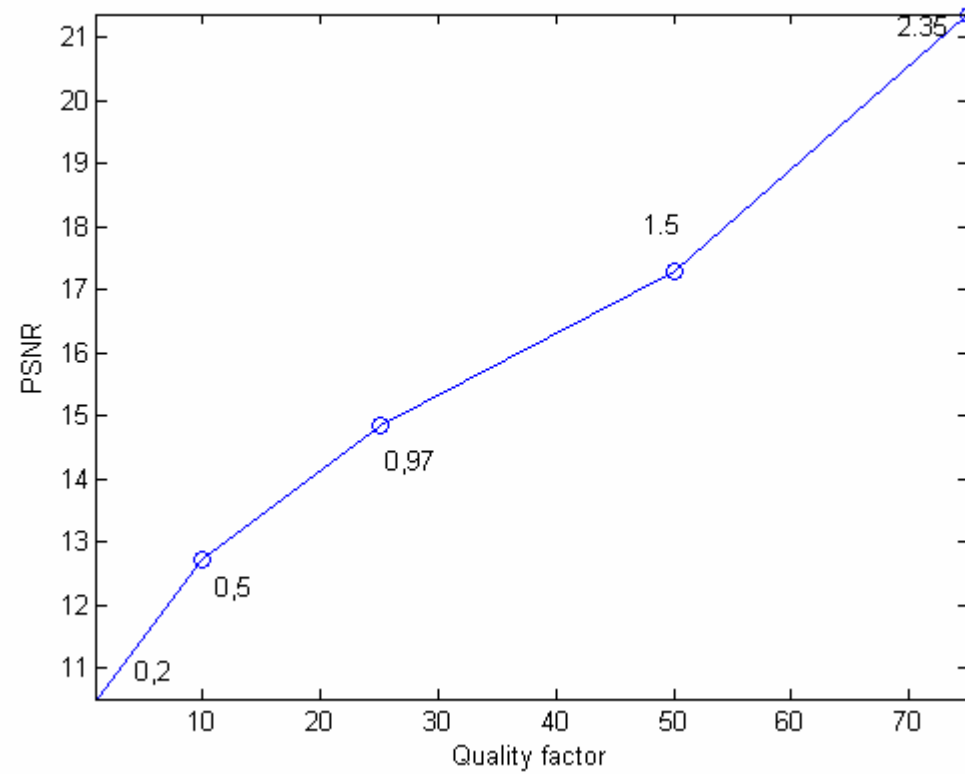

Pros&Cons

Pros

- Low complexity
- Memory efficient
- Reasonable coding efficiency
- Good image quality
- Adjustable image quality

Cons

- Single resolution
- Single quality
- No target bit-rate
- Blocking artifacts at low rates
- No region of interest (ROI) functionality
- No lossy and lossless representations on the same bitstream