

Basics of Signals and Systems

Gloria Menegaz

AA 2013-2014

Didactic material

- Textbook
 - Signal Processing and Linear Systems, B.P. Lathi, CRC Press
- Other books
 - Signals and Systems, Richard Baraniuk's lecture notes, available on line
 - Digital Signal Processing (4th Edition) (Hardcover), John G. Proakis, Dimitris K Manolakis
 - Teoria dei segnali analogici, M. Luise, G.M. Vitetta, A.A. D' Amico, McGraw-Hill
 - Signal processing and linear systems, Schaun's outline of digital signal processing
- All textbooks are available at the library
- Handwritten notes will be available on demand

Signals&Systems

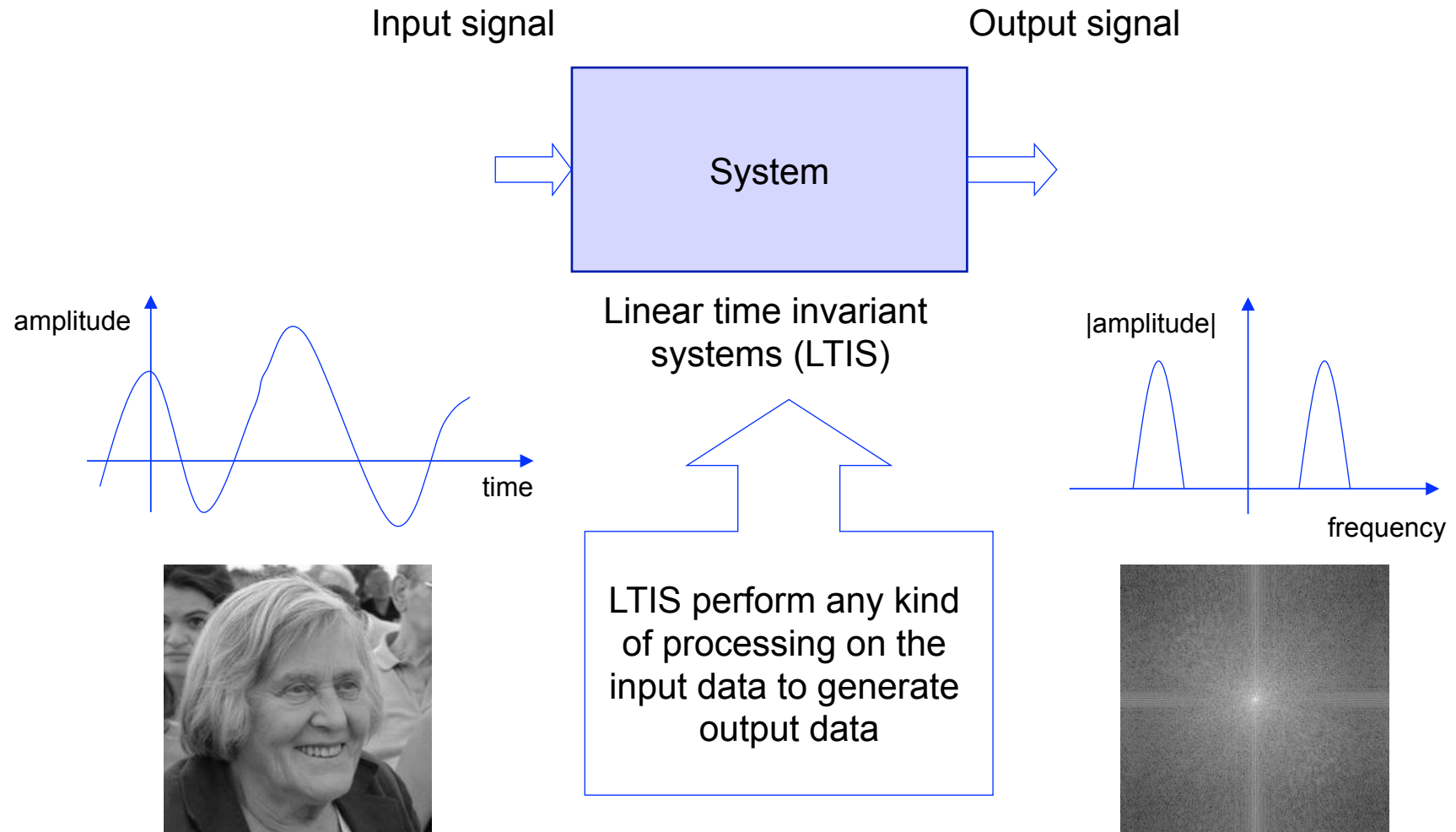

Contents

Signals

- Signal classification and representation
 - Types of signals
 - Sampling theory
 - Quantization
- Signal analysis
 - Fourier Transform
 - Continuous time, Fourier series, Discrete Time Fourier Transforms, Windowed FT
 - Spectral Analysis

Systems

- Linear Time-Invariant Systems
 - Time and frequency domain analysis
 - Impulse response
 - Stability criteria
- Digital filters
 - Finite Impulse Response (FIR)
- Mathematical tools
 - Laplace Transform
 - Basics
 - Z-Transform
 - Basics

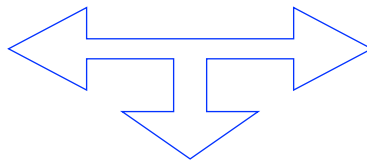

Applications in the domain of Bioinformatics

What is a signal?

- A signal is a set of information of data
 - Any kind of physical variable subject to variations represents a signal
 - Both the independent variable and the physical variable can be either scalars or vectors
 - Independent variable: time (t), space (x , $\mathbf{x}=[x_1, x_2]$, $\mathbf{x}=[x_1, x_2, x_3]$)
 - Signal:
 - Electrocardiography signal (EEG) 1D, voice 1D, music 1D
 - Images (2D), video sequences (2D+time), volumetric data (3D)

Example: 1D biological signals: ECG

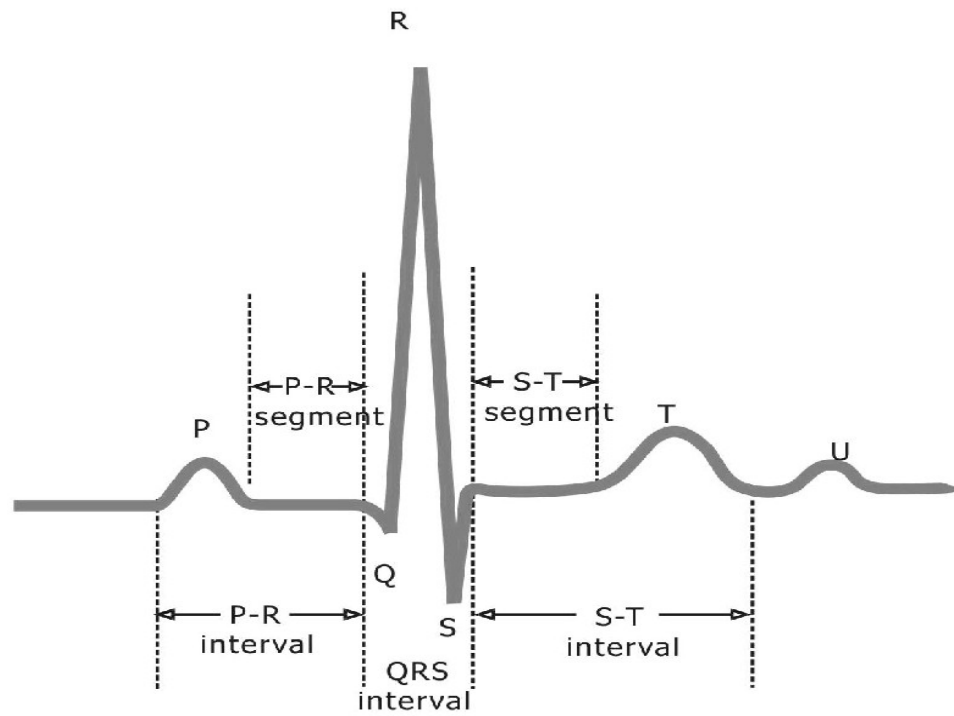

Example: 1D biological signals: EEG

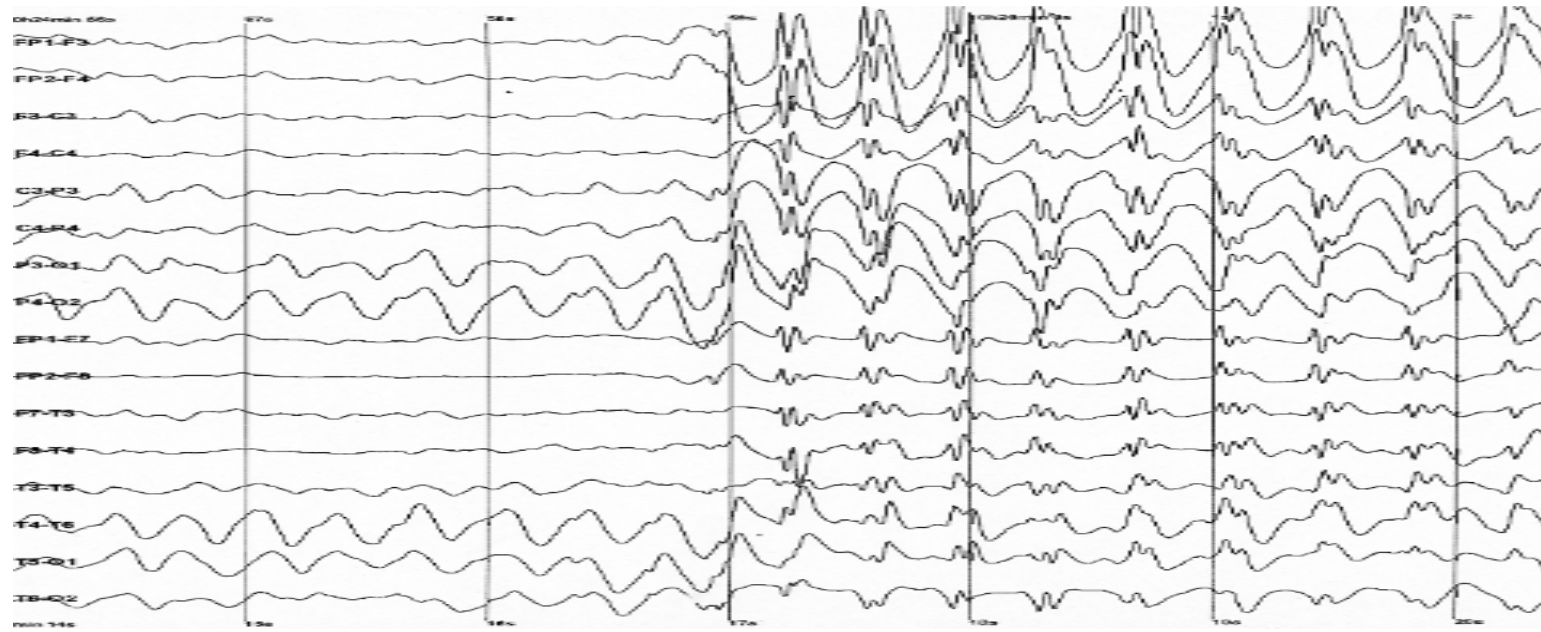
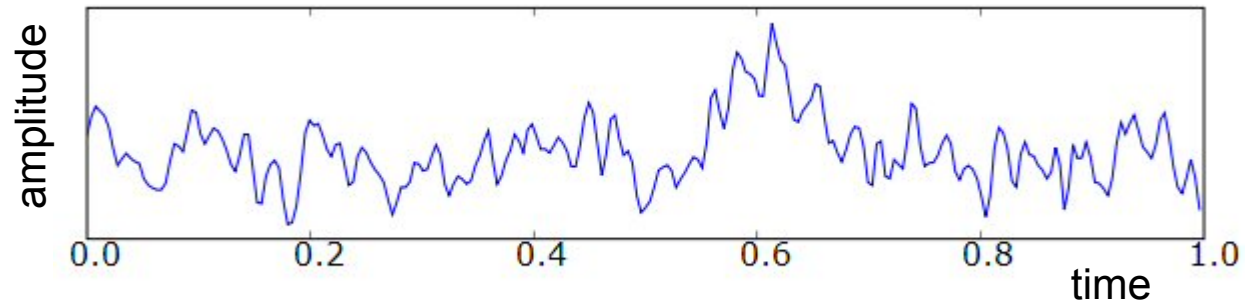

1D biological signals: DNA sequencing

GATCACAGGTCTATCACCTATTAACCACTCACGGGAGCTCTCCATG.....

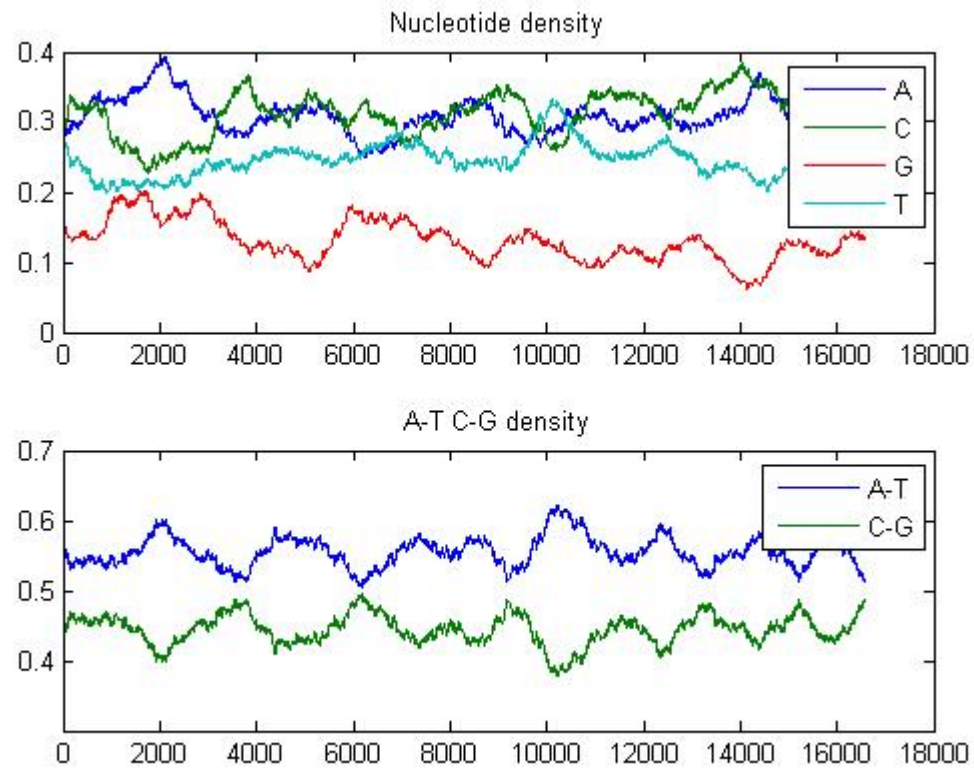

Example: 2D biological signals: MI

MRI

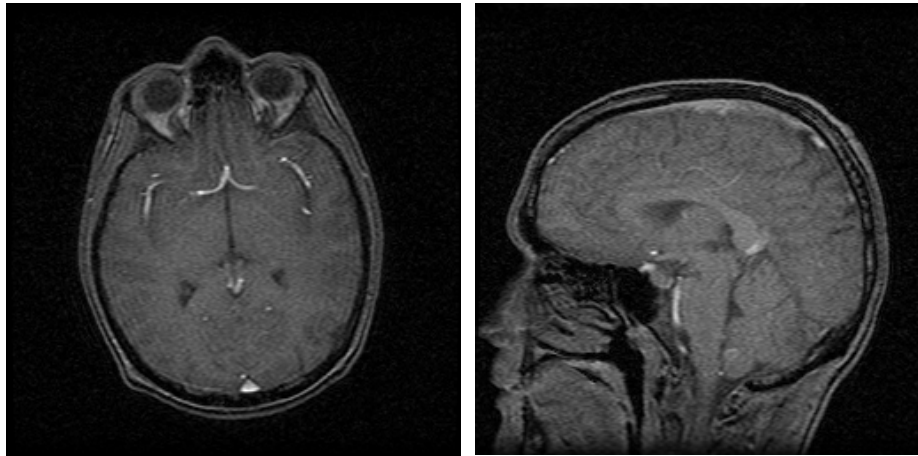

US

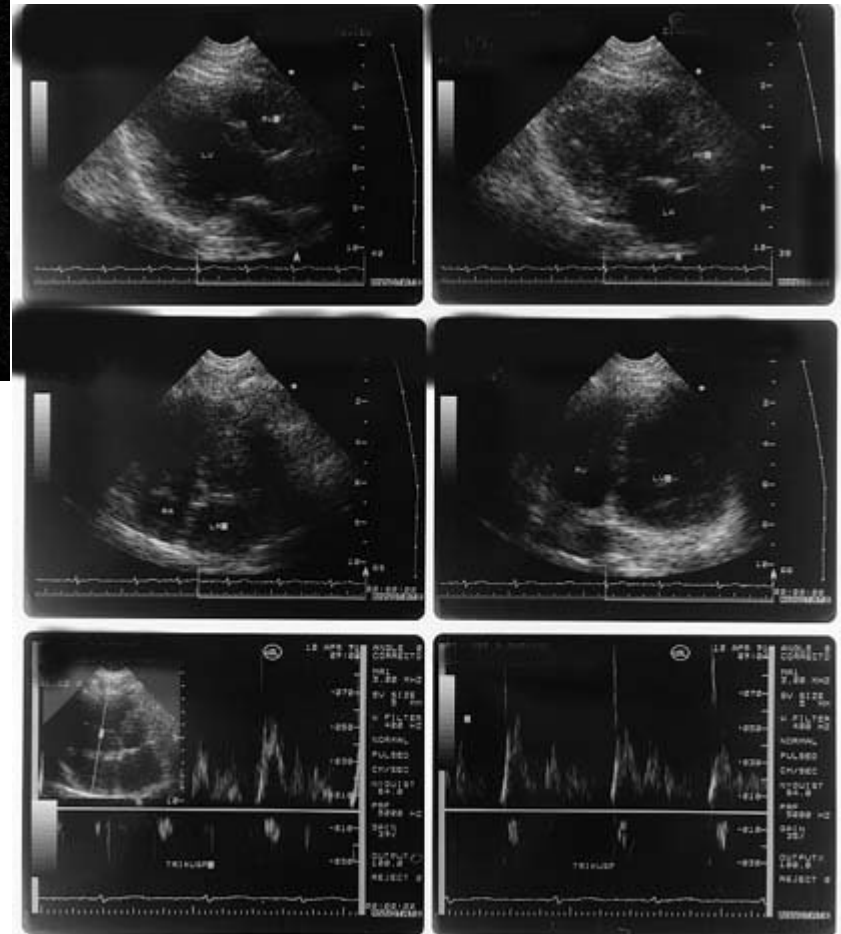

CT

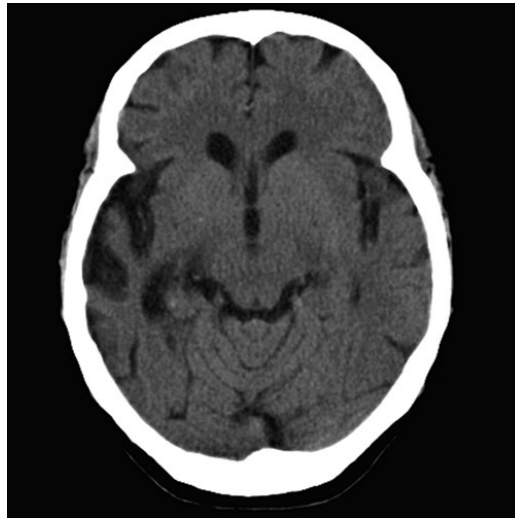

Example: 2D biological signals: microarrays

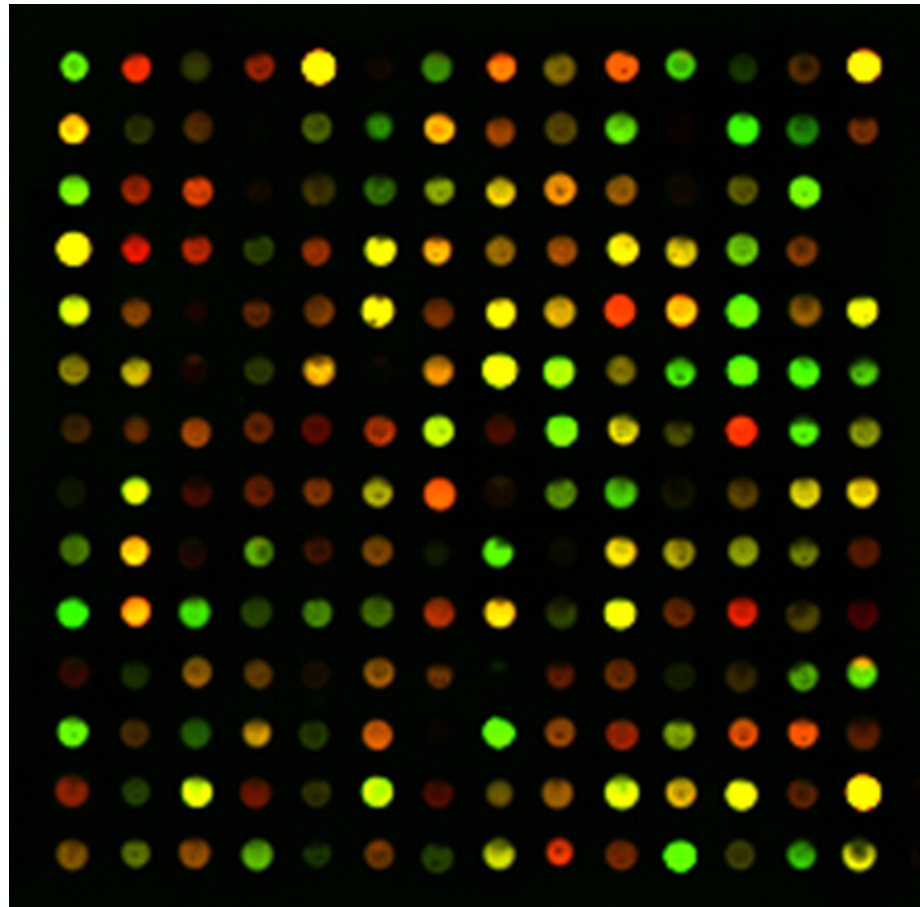

Signals as functions

- Continuous functions of real independent variables
 - 1D: $f=f(x)$
 - 2D: $f=f(x,y)$ x,y
 - Real world signals (audio, ECG, images)
- Real valued functions of discrete variables
 - 1D: $f=f[k]$
 - 2D: $f=f[i,j]$
 - *Sampled* signals
- Discrete functions of discrete variables
 - 1D: $f^d=f^d[k]$
 - 2D: $f^d=f^d[i,j]$
 - *Sampled and quantized* signals

Images as functions

- Gray scale images: 2D functions
 - Domain of the functions: set of (x,y) values for which $f(x,y)$ is defined : 2D lattice $[i,j]$ defining the pixel locations
 - Set of values taken by the function : gray levels
- Digital images can be seen as functions defined over a discrete domain $\{i,j: 0 < i < I, 0 < j < J\}$
 - I,J : number of rows (columns) of the matrix corresponding to the image
 - $f=f[i,j]$: gray level in position $[i,j]$

Example 1: δ function

$$\delta[i, j] = \begin{cases} 1 & i = j = 0 \\ 0 & i, j \neq 0; i \neq j \end{cases}$$

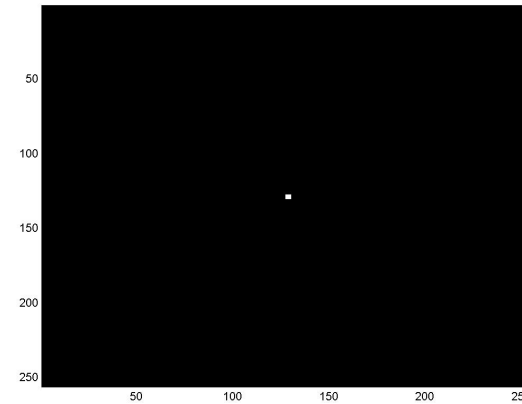

$$\delta[i, j - J] = \begin{cases} 1 & i = 0; j = J \\ 0 & \textit{otherwise} \end{cases}$$

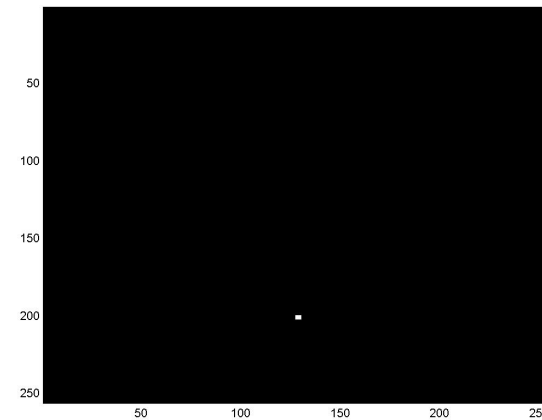

Example 2: Gaussian

Continuous function

$$f(x, y) = \frac{1}{\sigma\sqrt{2\pi}} e^{-\frac{x^2+y^2}{2\sigma^2}}$$

Discrete version

$$f[i, j] = \frac{1}{\sigma\sqrt{2\pi}} e^{-\frac{i^2+j^2}{2\sigma^2}}$$

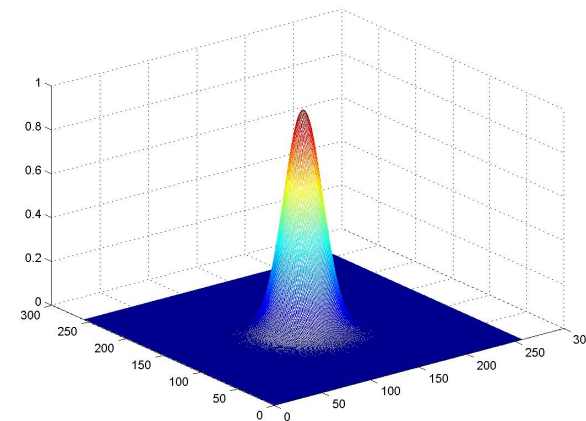
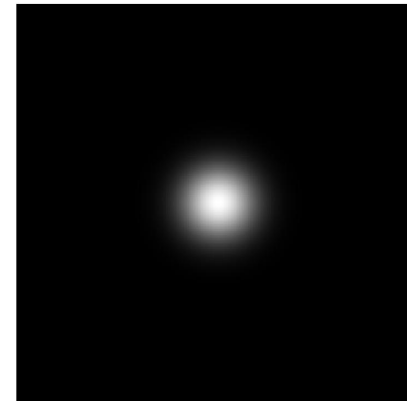

Example 3: Natural image

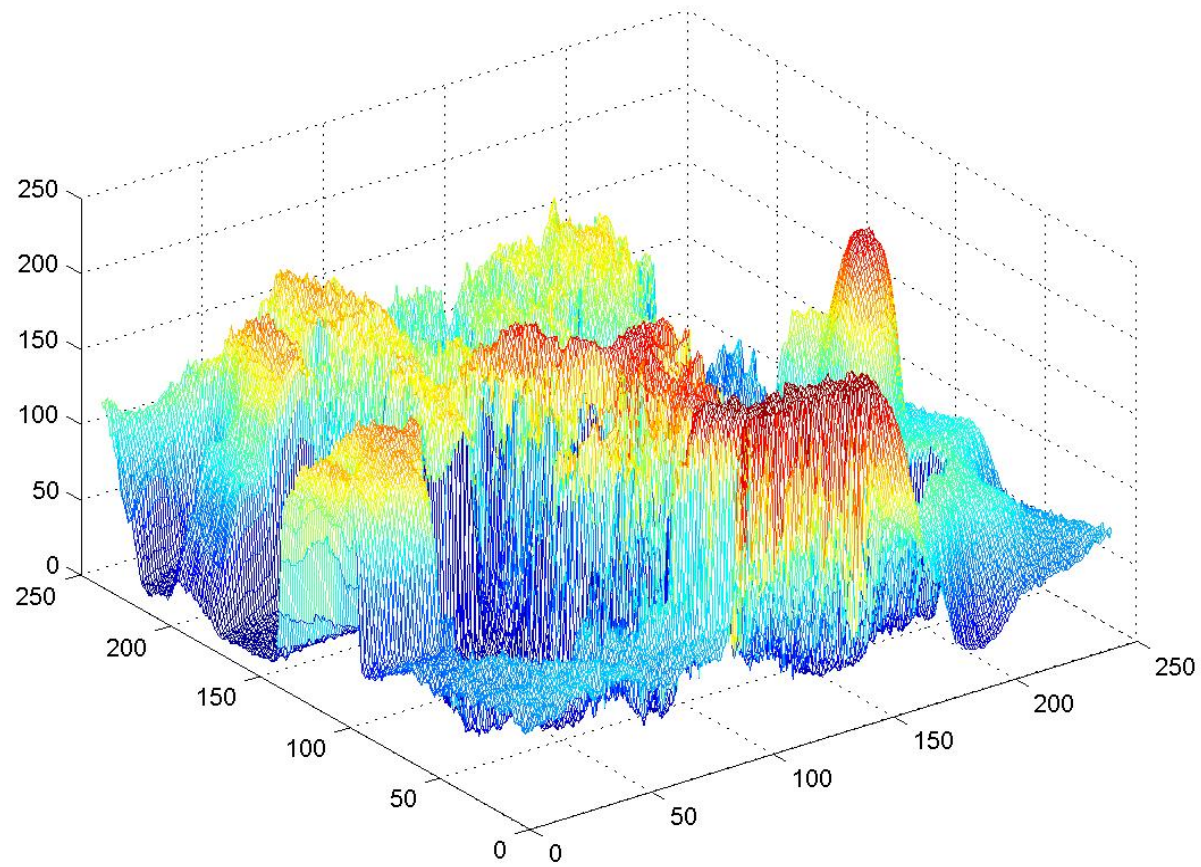

Example 3: Natural image



What is a system?

- Systems process signals to
 - Extract information (DNA sequence analysis)
 - Enable transmission over channels with limited capacity (JPEG, JPEG2000, MPEG coding)
 - Improve security over networks (encryption, watermarking)
 - Support the formulation of diagnosis and treatment planning (medical imaging)
 -

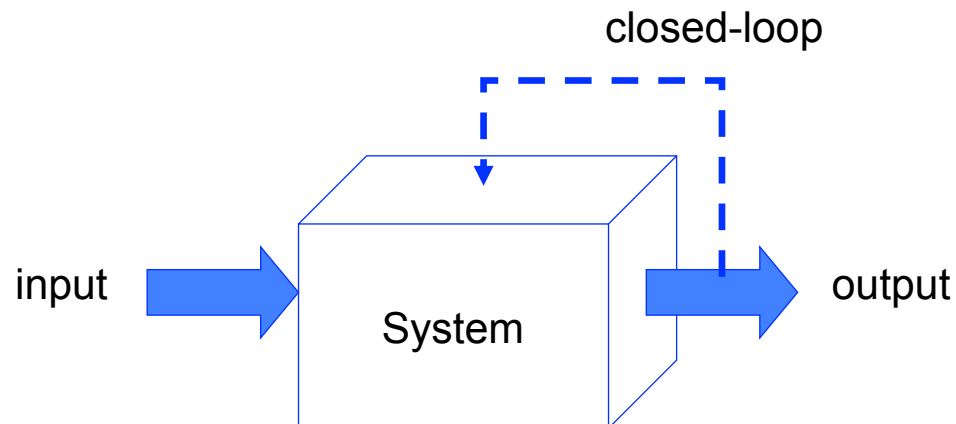

The function linking the output of the system with the input signal is called **transfer function** and it is typically indicated with the symbol $h(\bullet)$

Classification of signals

- Continuous time – Discrete time
- Analog – Digital (numerical)
- Periodic – Aperiodic
- Energy – Power
- Deterministic – Random (probabilistic)
- Note
 - Such classes are not disjoint, so there are digital signals that are periodic of power type and others that are aperiodic of power type etc.
 - Any combination of single features from the different classes is possible

Continuous time – discrete time

- Continuous time signal: a signal that is specified for every real value of the independent variable
 - The independent variable is continuous, that is it takes any value on the real axis
 - The domain of the function representing the signal has the cardinality of real numbers
 - Signal $\leftrightarrow f=f(t)$
 - Independent variable \leftrightarrow time (t), position (x)
 - For continuous-time signals: $t \in \mathbb{R}$

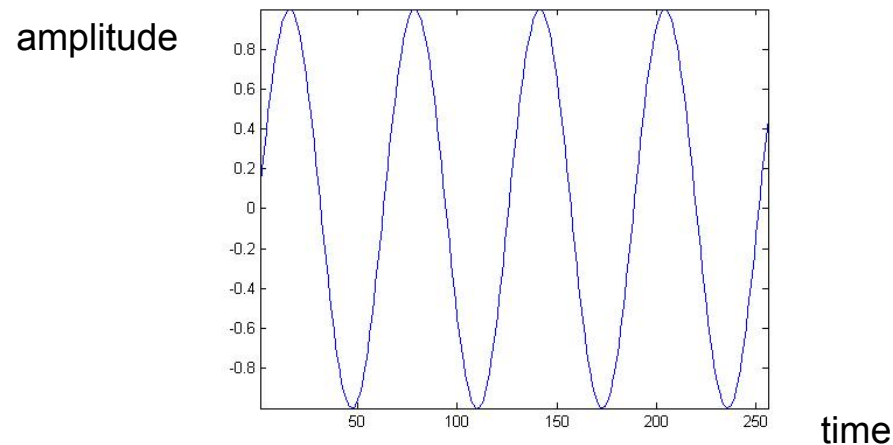

Continuous time – discrete time

- Discrete time signal: a signal that is specified only for *discrete values* of the independent variable
 - It is usually generated by *sampling* so it will only have values at *equally spaced* intervals along the time axis
 - The domain of the function representing the signal has the cardinality of integer numbers
 - Signal $\leftrightarrow f=f[n]$, also called “sequence”
 - Independent variable $\leftrightarrow n$
 - For discrete-time functions: $t \in \mathbf{Z}$

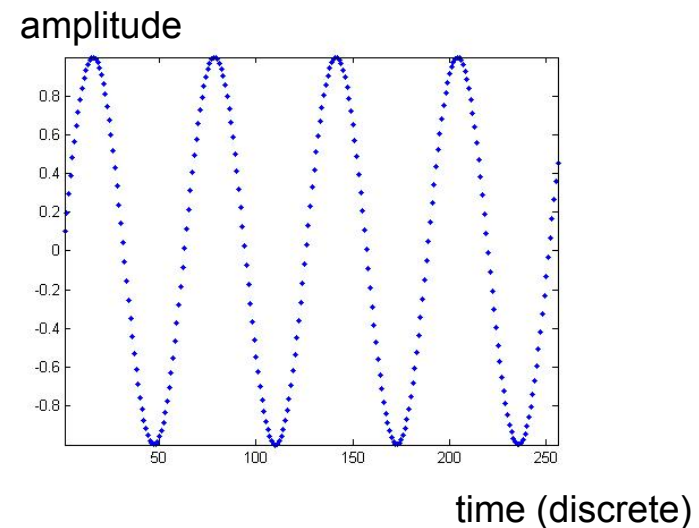
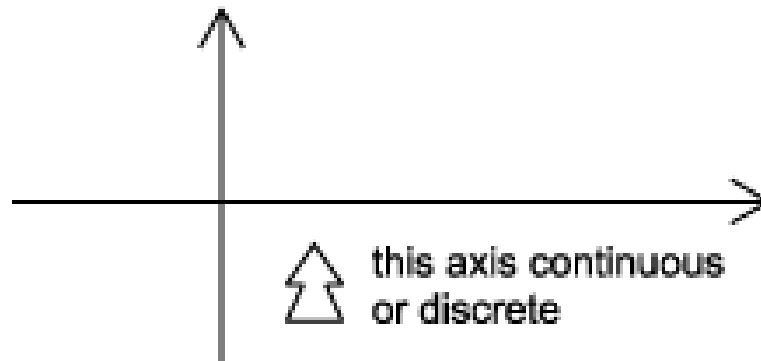

Analog - Digital

- **Analog signal:** signal whose amplitude can take on any value in a continuous range
 - The amplitude of the function $f(t)$ (or $f(x)$) has the cardinality of real numbers
 - The difference between analog and digital is similar to the difference between continuous-time and discrete-time. In this case, however, the difference is with respect to the value of the function (y-axis)
 - Analog corresponds to a continuous y-axis, while digital corresponds to a discrete y-axis

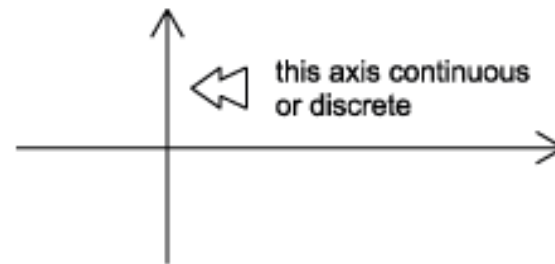

- *Here we call digital what we have called quantized in the EI class*
- *An analog signal can be both continuous time and discrete time*

Analog - Digital

- **Digital signal:** a signal is one whose amplitude can take on only a finite number of values (thus it is quantized)
 - The amplitude of the function $f()$ can take only a finite number of values
 - A digital signal whose amplitude can take only M different values is said to be M -ary
 - Binary signals are a special case for $M=2$

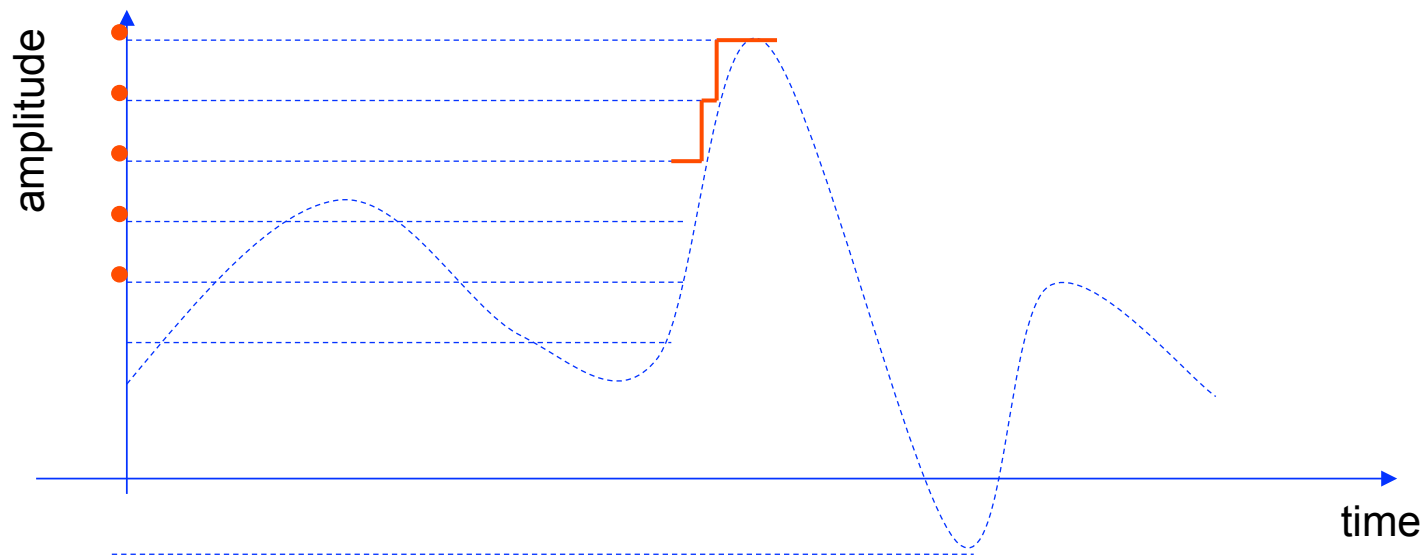

Example

- Continuous time analog

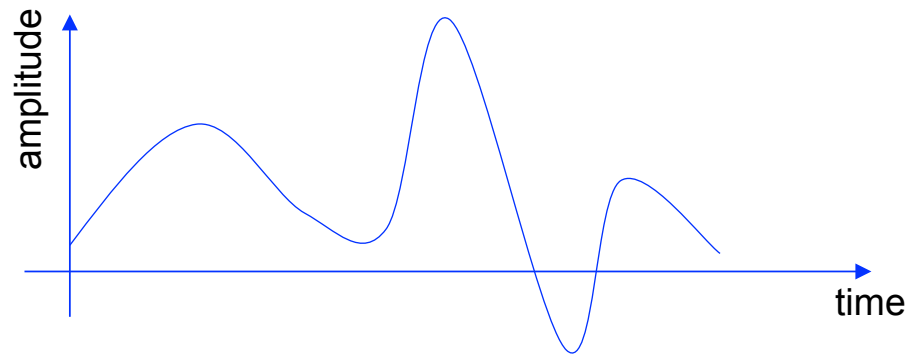

- Continuous time digital (or quantized)

- binary sequence, where the values of the function can only be one or zero.

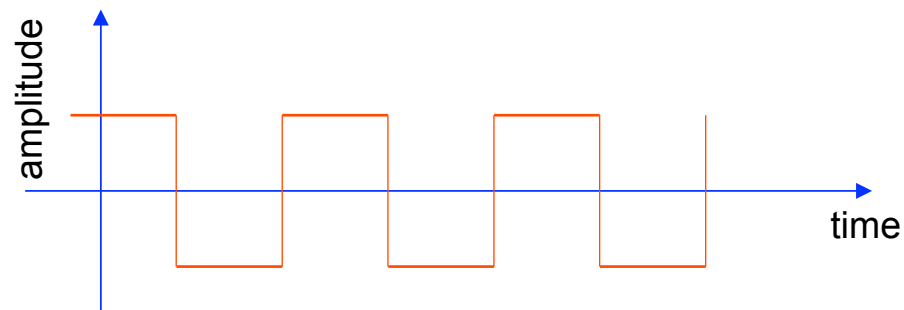

Example

- Discrete time analog

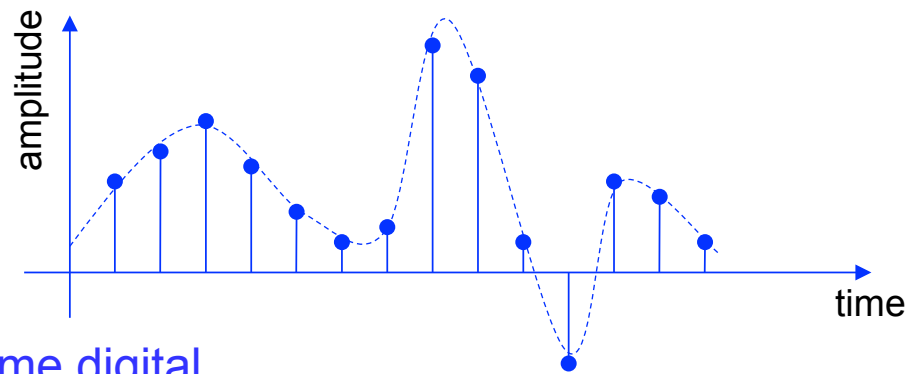

- Discrete time digital

- binary sequence, where the values of the function can only be one or zero.

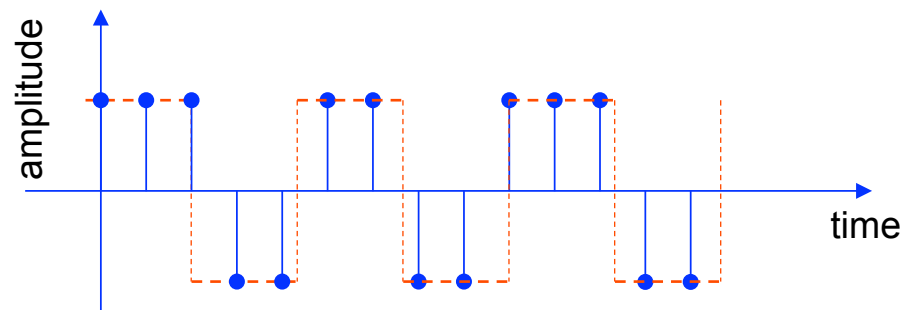

Summary

Signal amplitude/ Time or space	Real	Integer
Real	Analog Continuous-time	Digital Continuous-time
Integer	Analog Discrete-time	Digital Discrete time

Note

- In the image processing class we have defined as digital those signals that are both quantized and discrete time. It is a more restricted definition.
- The definition used here is as in the Lathi book.

Periodic - Aperiodic

- A signal $f(t)$ is *periodic* if there exists a positive constant T_0 such that

$$f(t + T_0) = f(t) \quad \forall t$$

- The *smallest* value of T_0 which satisfies such relation is said the *period* of the function $f(t)$
- A periodic signal remains unchanged when *time-shifted* of integer multiples of the period
- Therefore, by definition, it starts at minus infinity and lasts forever

$$-\infty \leq t \leq +\infty \quad t \in \mathbb{R}$$

$$-\infty \leq n \leq +\infty \quad n \in \mathbb{Z}$$

- Periodic signals can be generated by *periodical extension*

Examples

- Periodic signal with period T_0

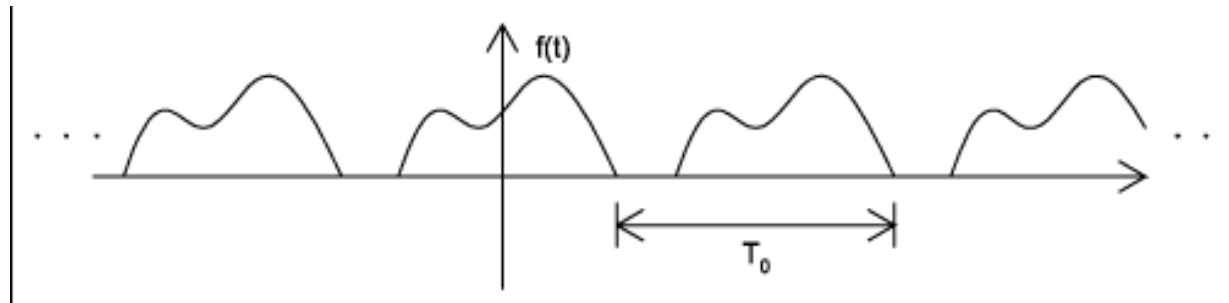

- Aperiodic signal

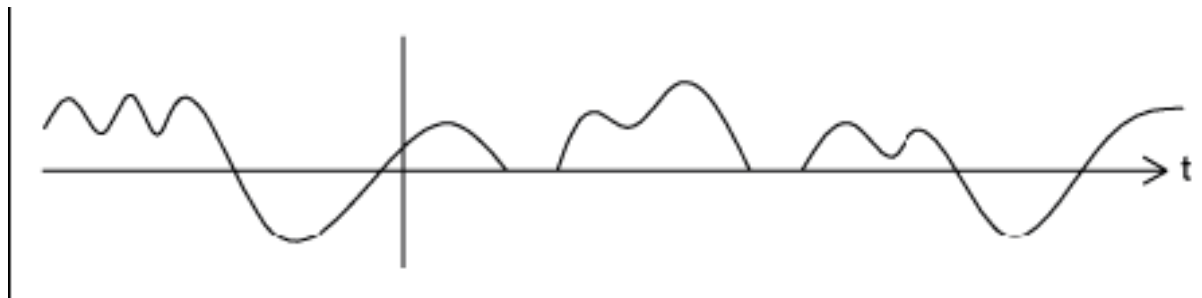

Causal and non-Causal signals

- *Causal* signals are signals that are zero for all negative time (or spatial positions), while
- *Anticausal* are signals that are zero for all positive time (or spatial positions).
- *Noncausal* signals are signals that have nonzero values in both positive and negative time

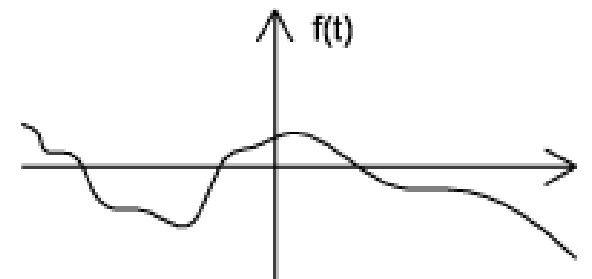
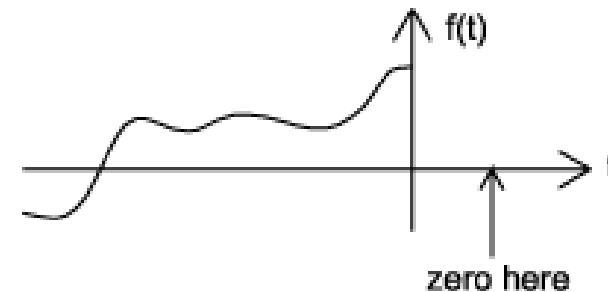
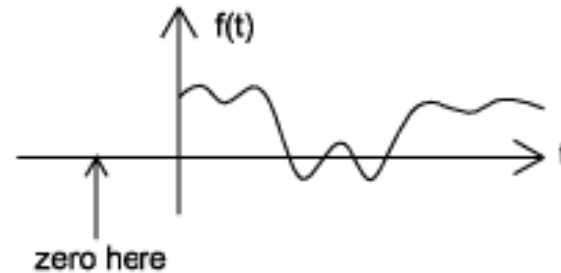

Causal and non-causal signals

- Causal signals

$$f(t) = 0 \quad t < 0$$

- Anticausals signals

$$f(t) = 0 \quad t \geq 0$$

- Non-causal signals

$$\exists t_1 < 0: \quad f(t_1) \neq 0$$

Even and Odd signals

- An even signal is any signal f such that $f(t) = f(-t)$. Even signals can be easily spotted as they are symmetric around the vertical axis.

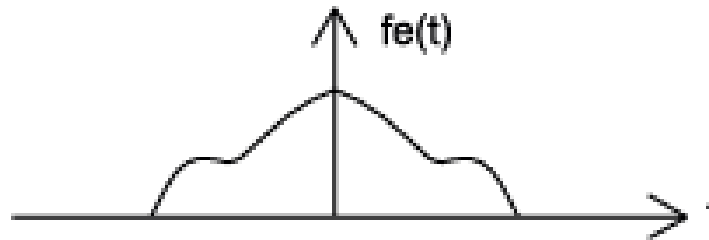

- An odd signal, on the other hand, is a signal f such that $f(t) = -f(-t)$

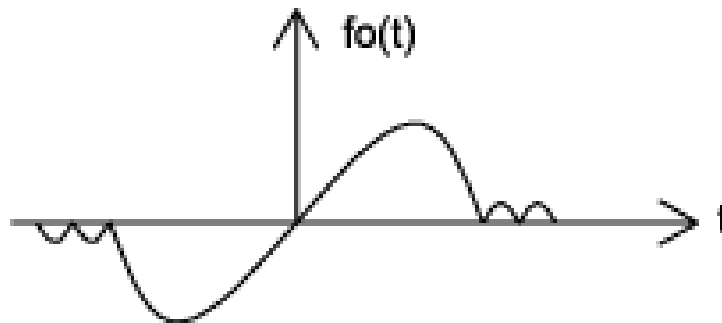

Decomposition in even and odd components

- Any signal can be written as a combination of an even and an odd signals
 - Even and odd components

$$f(t) = \frac{1}{2}(f(t) + f(-t)) + \frac{1}{2}(f(t) - f(-t))$$

$$f_e(t) = \frac{1}{2}(f(t) + f(-t)) \quad \text{even component}$$

$$f_o(t) = \frac{1}{2}(f(t) - f(-t)) \quad \text{odd component}$$

$$f(t) = f_e(t) + f_o(t)$$

Example

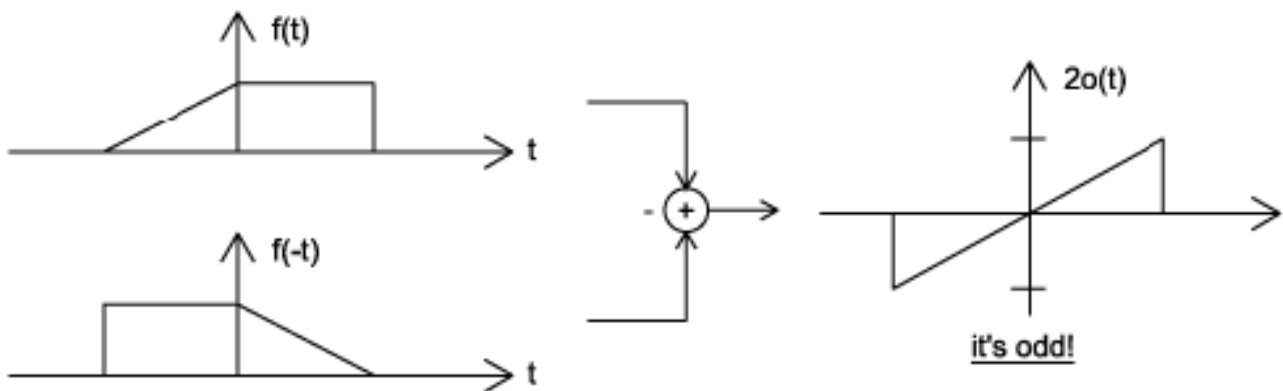
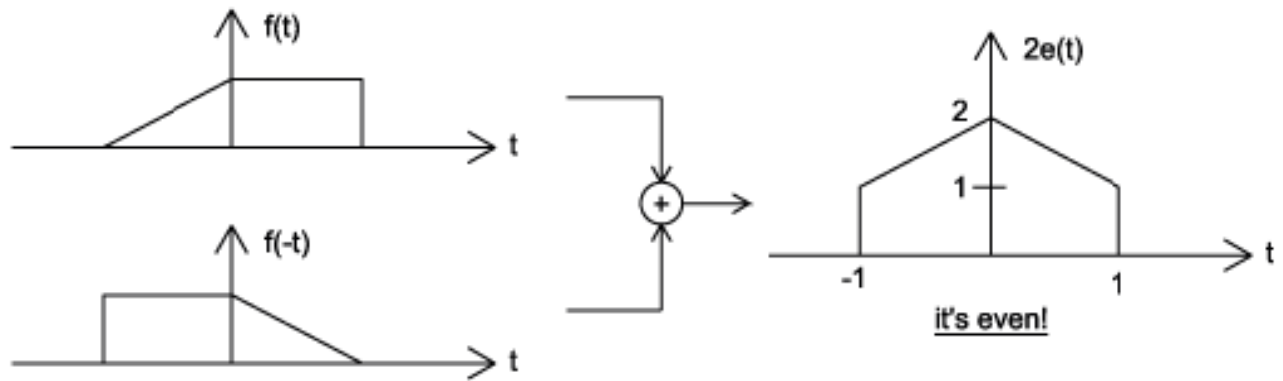
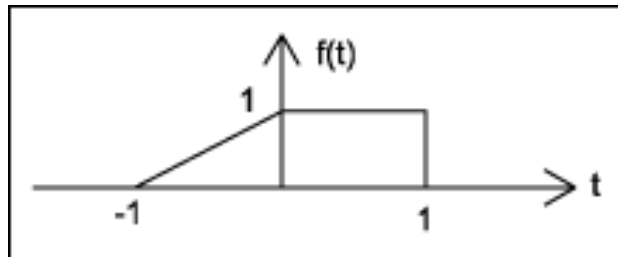

Example

- Proof

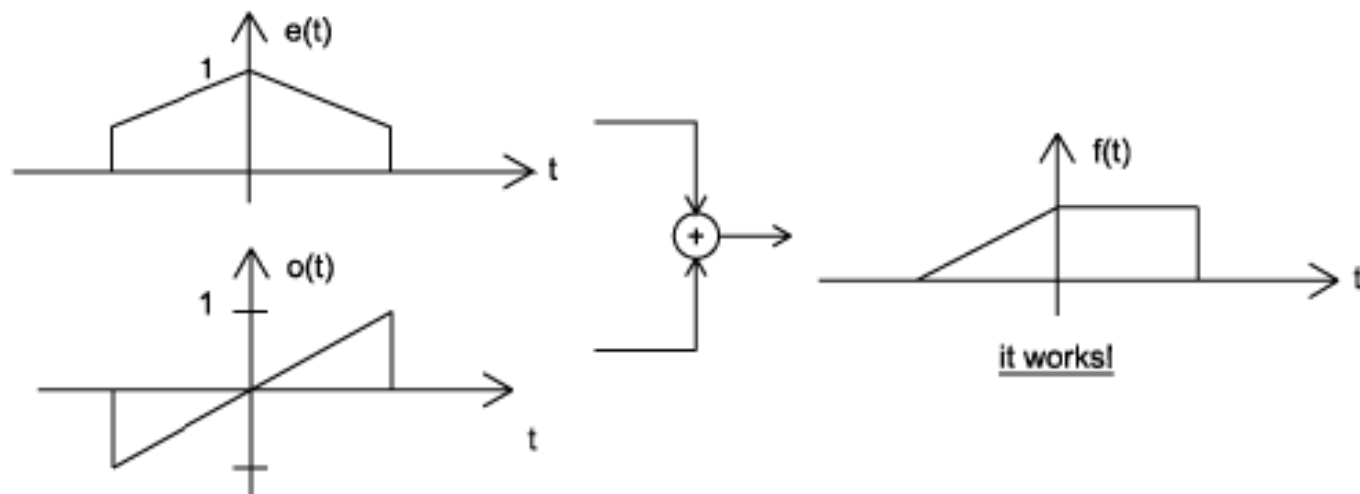

Some properties of even and odd functions

- even function x odd function = odd function
- odd function x odd function = even function
- even function x even function = even function
- Area

$$\int_{-a}^a f_e(t) dt = 2 \int_0^a f_e(t) dt$$

$$\int_{-a}^a f_o(t) dt = 0$$

Deterministic - Probabilistic

- Deterministic signal: a signal whose *physical description* is known completely
- A deterministic signal is a signal in which each value of the signal is fixed and can be determined by a mathematical expression, rule, or table.
- Because of this the future values of the signal can be calculated from past values with complete confidence.
 - There is *no uncertainty* about its amplitude values
 - Examples: signals defined through a mathematical function or graph
- Probabilistic (or random) signals: the amplitude values *cannot be predicted precisely* but are known only in terms of probabilistic descriptors
- The future values of a random signal cannot be accurately predicted and can usually only be guessed based on the averages of sets of signals
 - They are realization of a stochastic process for which a model could be available
 - Examples: EEG, evoked potentials, noise in CCD capture devices for digital cameras

Example

- Deterministic signal

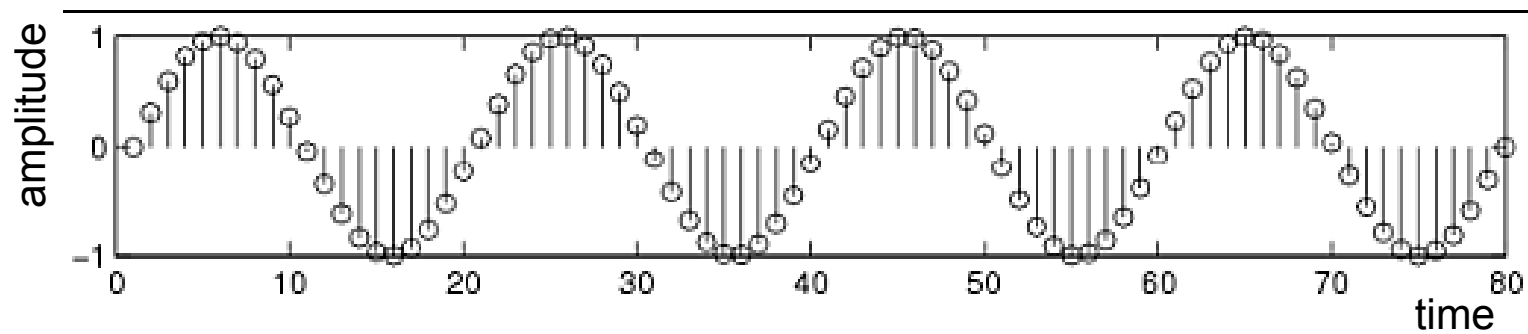

- Random signal

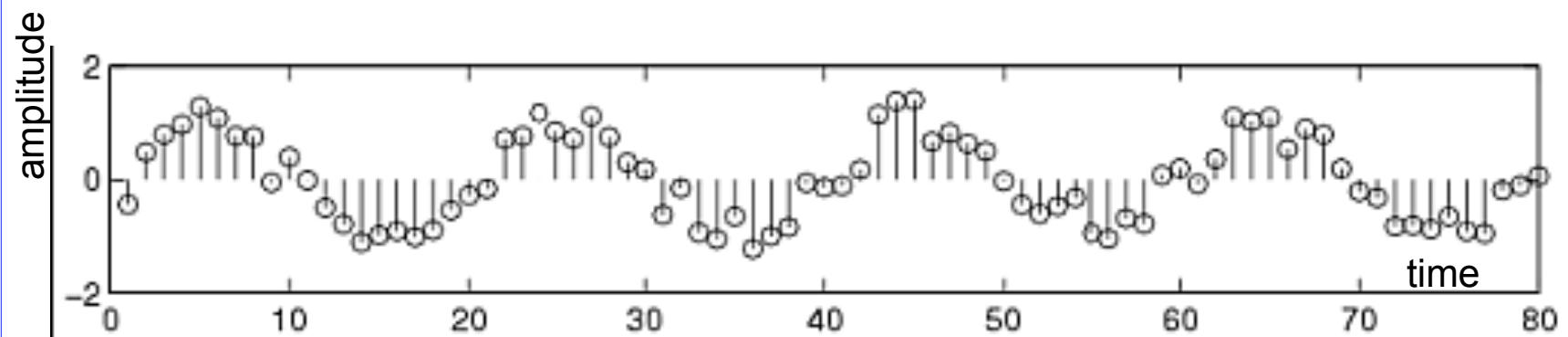

Finite and Infinite length signals

- A finite length signal is non-zero over a finite set of values of the independent variable

$$f = f(t), \forall t : t_1 \leq t \leq t_2$$
$$t_1 > -\infty, t_2 < +\infty$$

- An infinite length signal is non zero over an infinite set of values of the independent variable
 - For instance, a sinusoid $f(t)=\sin(\omega t)$ is an infinite length signal

Size of a signal: Norms

- "Size" indicates largeness or strength.
- We will use the mathematical concept of the norm to quantify this notion for both continuous-time and discrete-time signals.
- The energy is represented by the area under the curve (of the squared signal)

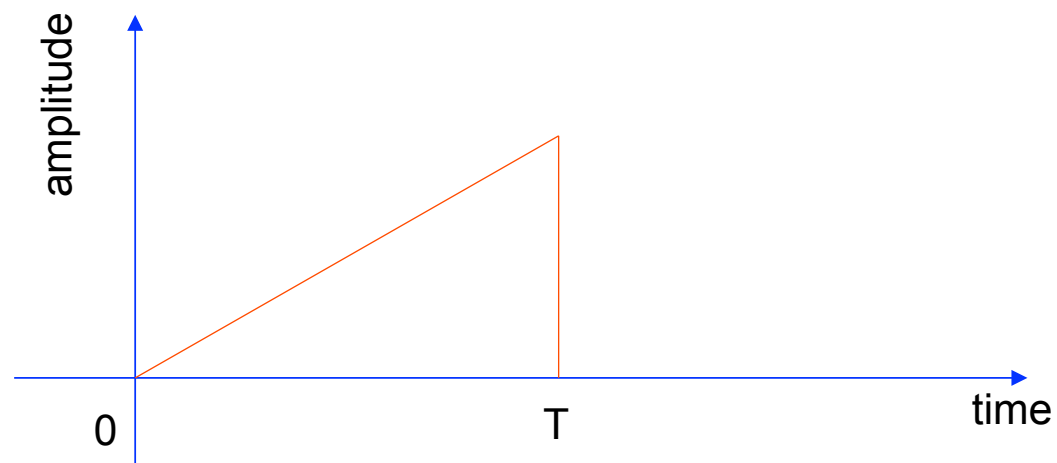

Energy

- Signal energy

$$E_f = \int_{-\infty}^{+\infty} f^2(t) dt$$

$$E_f = \int_{-\infty}^{+\infty} |f(t)|^2 dt$$

- Generalized energy : L_p norm

- For $p=2$ we get the energy (L_2 norm)

$$\|f(t)\| = \left(\int (|f(t)|)^p dt \right)^{1/p}$$

$$1 \leq p < +\infty$$

Power

- Power

- The power is the time average (mean) of the squared signal amplitude, that is the *mean-squared* value of $f(t)$

$$P_f = \lim_{T \rightarrow \infty} \frac{1}{T} \int_{-T/2}^{+T/2} f^2(t) dt$$

$$P_f = \lim_{T \rightarrow \infty} \frac{1}{T} \int_{-T/2}^{+T/2} |f(t)|^2 dt$$

Power - Energy

- The square root of the power is the root mean square (*rms*) value
 - This is a very important quantity as it is the most widespread measure of similarity/dissimilarity among signals
 - It is the basis for the definition of the Signal to Noise Ratio (SNR)

$$SNR = 20 \log_{10} \left(\sqrt{\frac{P_{signal}}{P_{noise}}} \right)$$

- It is such that a constant signal whose amplitude is =rms holds the same power content of the signal itself
- There exists signals for which neither the energy nor the power are finite

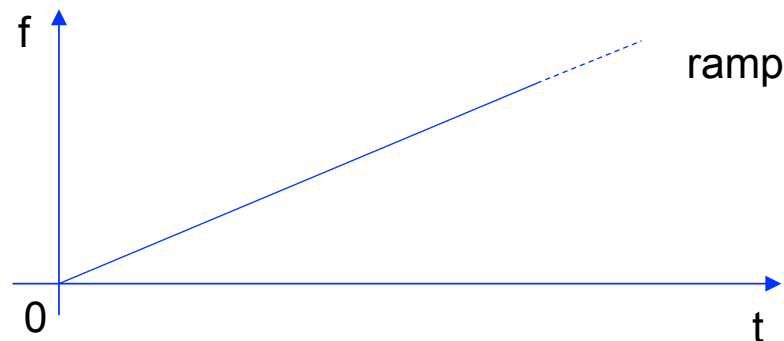

Energy and Power signals

- A signal with finite energy is an energy signal
 - Necessary condition for a signal to be of energy type is that the amplitude goes to zero as the independent variable tends to infinity
- A signal with finite and different from zero power is a power signal
 - The mean of an entity averaged over an infinite interval exists if either the entity is periodic or it has some statistical regularity
 - A power signal has infinite energy and an energy signal has zero power
 - There exist signals that are neither power nor energy, such as the ramp
- All practical signals have finite energy and thus are energy signals
 - It is impossible to generate a real power signal because this would have infinite duration and infinite energy, which is not doable.

Useful signal operations: shifting, scaling, inversion

- **Shifting:** consider a signal $f(t)$ and the same signal delayed/anticipated by T seconds

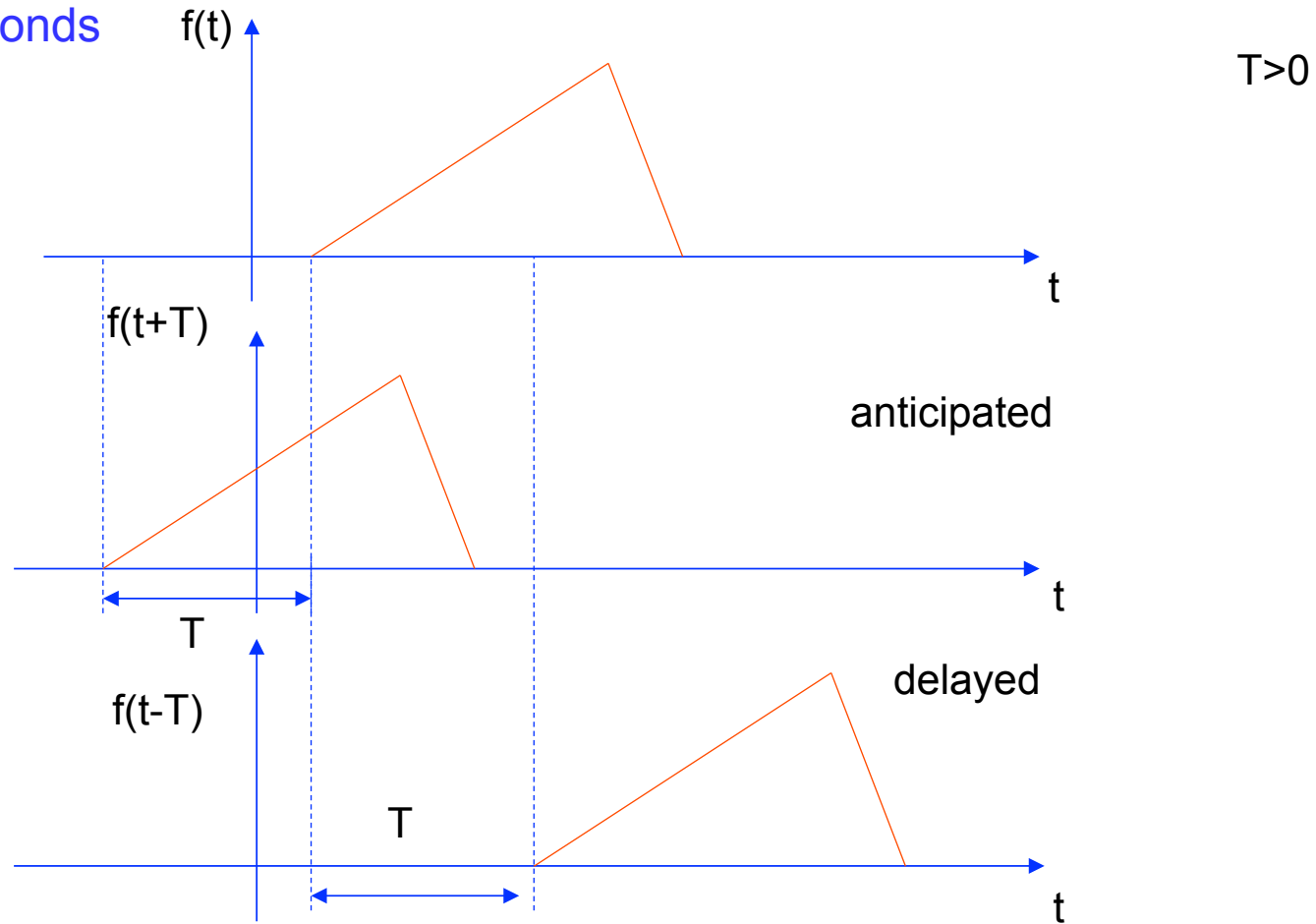

Useful signal operations: shifting, scaling, inversion

- (Time) Scaling: compression or expansion of a signal in time

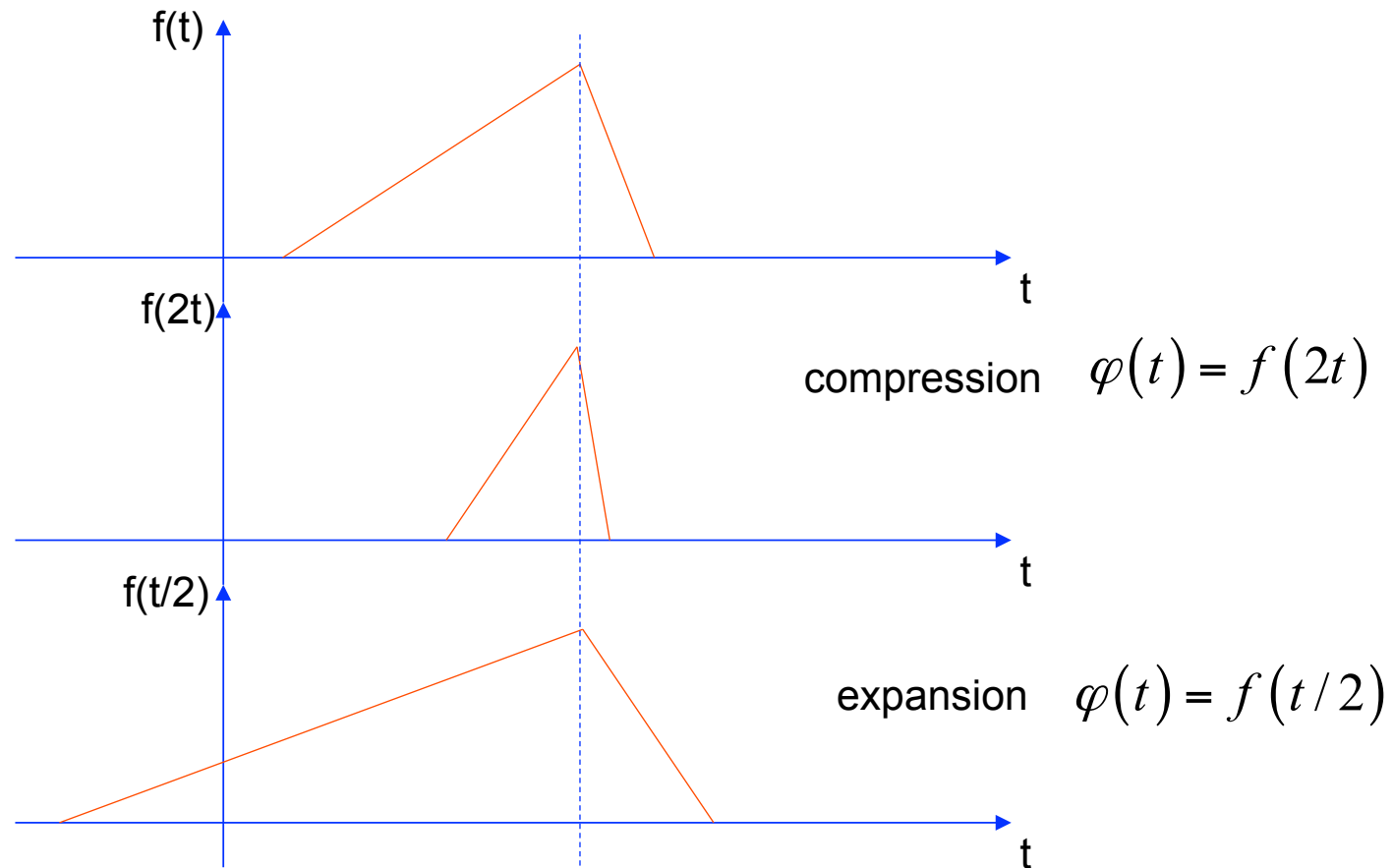

Useful signal operations: shifting, scaling, inversion

- Scaling: generalization

$$a > 1$$

$$\varphi(t) = f(at) \rightarrow \text{compressed version}$$

$$\varphi(t) = f\left(\frac{t}{a}\right) \rightarrow \text{dilated (or expanded) version}$$

Viceversa for $a < 1$

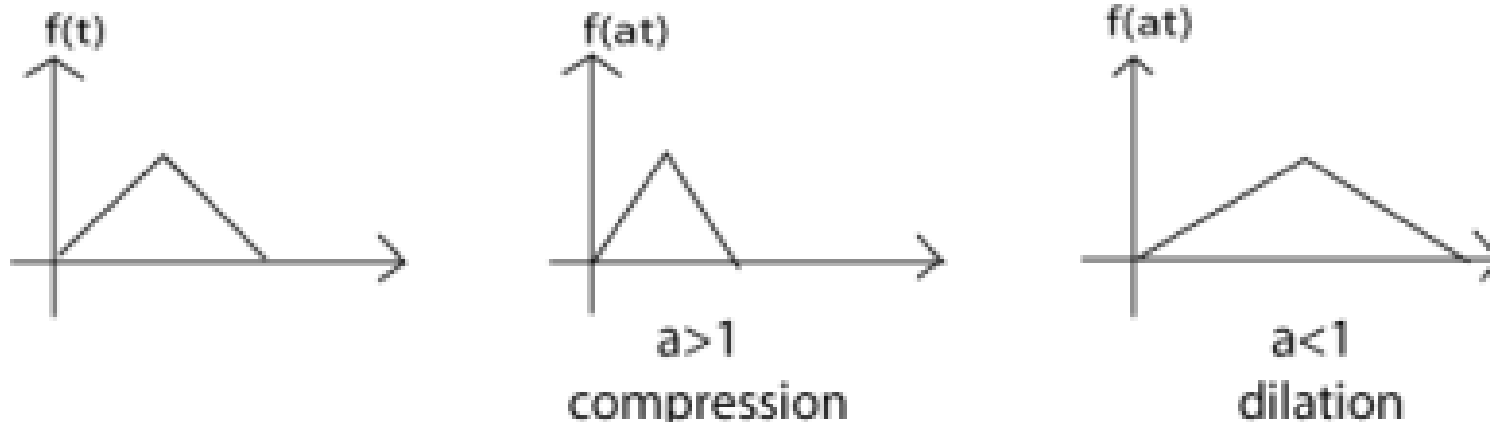

Useful signal operations: shifting, scaling, inversion

- (Time) inversion: mirror image of $f(t)$ about the vertical axis

$$\varphi(t) = f(-t)$$

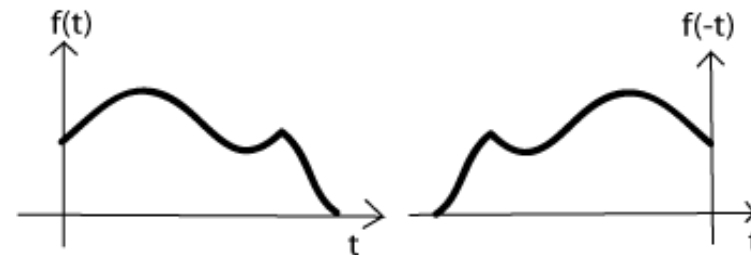
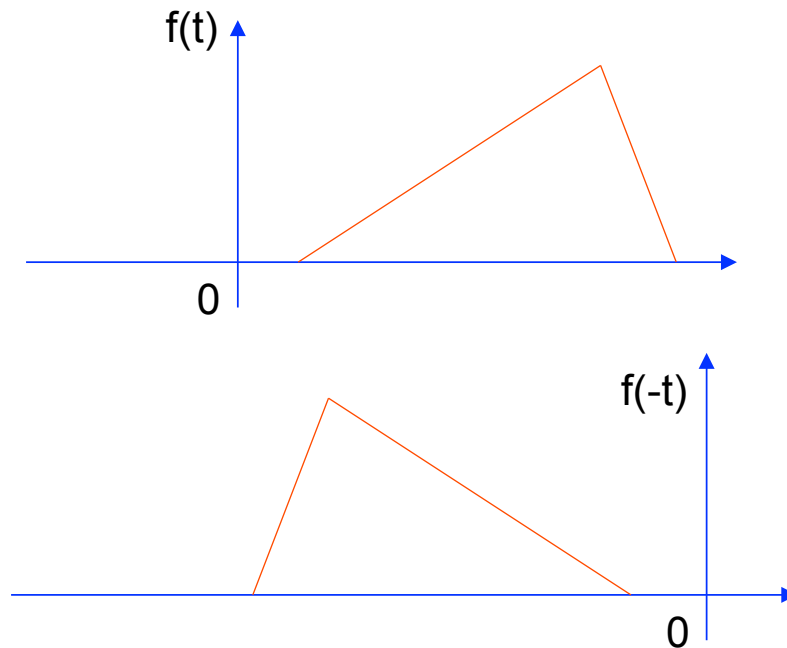

Useful signal operations: shifting, scaling, inversion

- Combined operations: $f(t) \rightarrow f(at-b)$
- Two possible sequences of operations
 1. Time shift $f(t)$ by t to obtain $f(t-b)$. Now time scale the shifted signal $f(t-b)$ by a to obtain $f(at-b)$.
 2. Time scale $f(t)$ by a to obtain $f(at)$. Now time shift $f(at)$ by b/a to obtain $f(at-b)$.
 - Note that you have to replace t by $(t-b/a)$ to obtain $f(at-b)$ from $f(at)$ when replacing t by the translated argument (namely $t-b/a$)

Useful functions

- Unit step function
 - Useful for representing causal signals

$$u(t) = \begin{cases} 1 & t \geq 0 \\ 0 & t < 0 \end{cases}$$

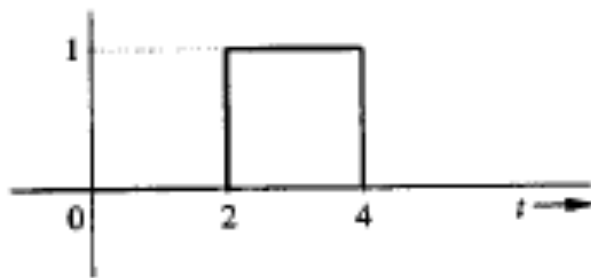

(a)

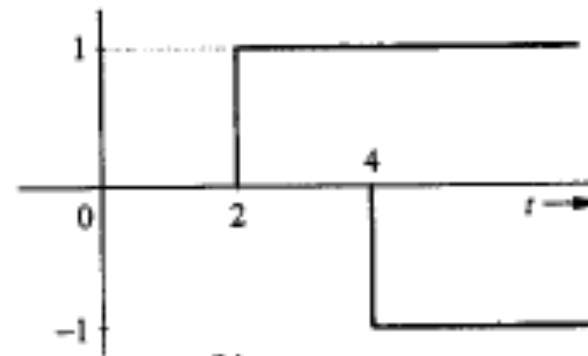

(b)

Fig. 1.15 Representation of a rectangular pulse by step functions.

$$f(t) = u(t - 2) - u(t - 4)$$

Useful functions

- Continuous and discrete time unit step functions

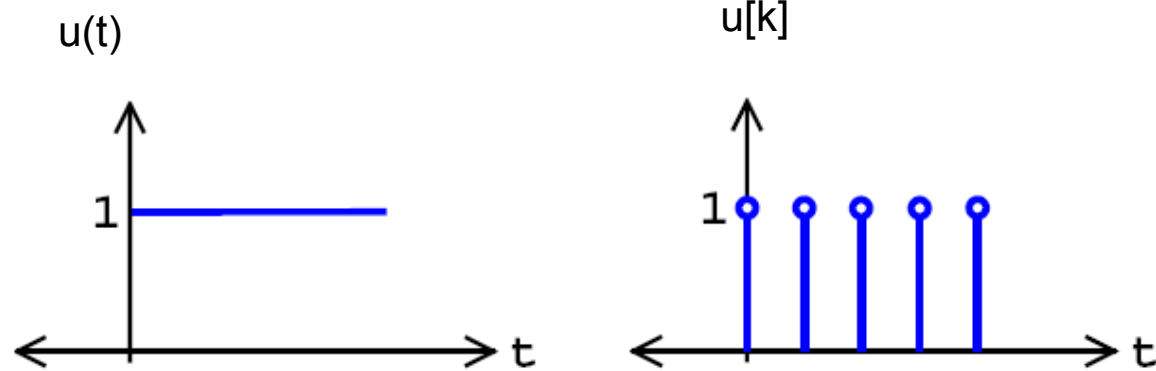

Useful functions

- Ramp function (continuous time)

$$r(t) = \begin{cases} 0 & \text{if } t < 0 \\ \frac{t}{t_0} & \text{if } 0 \leq t \leq t_0 \\ 1 & \text{if } t > t_0 \end{cases}$$

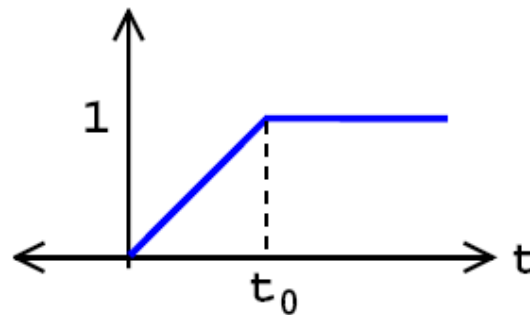

Useful functions

- Unit impulse function

$$\delta(t) = 0 \quad t \neq 0$$

$$\int_{-\infty}^{+\infty} \delta(t) dt = 1$$

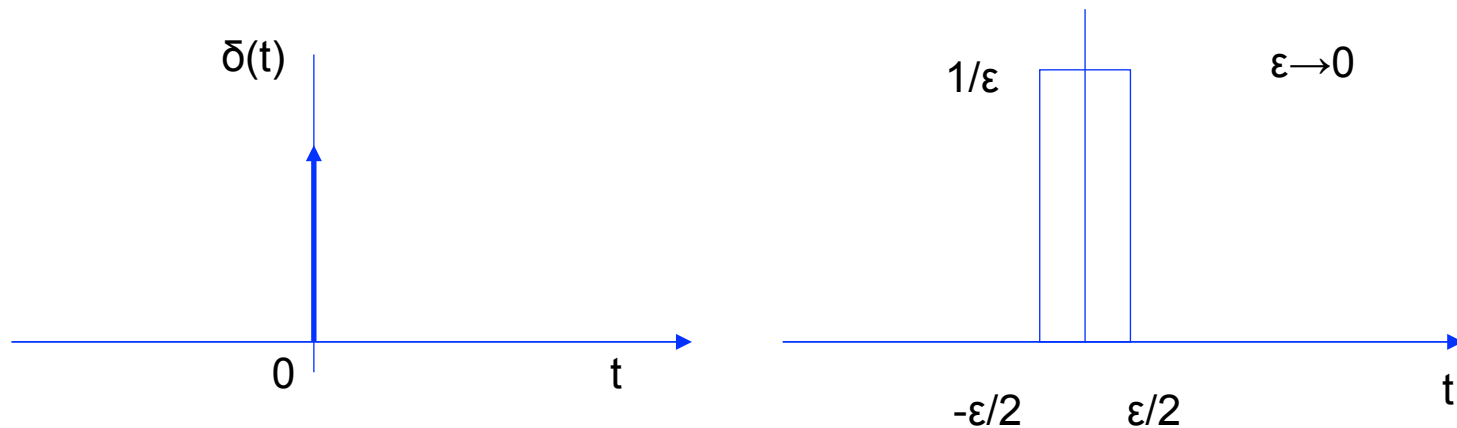

Properties of the unit impulse function

- Multiplication of a function by impulse

$$\phi(t)\delta(t) = \phi(0)\delta(t)$$

$$\phi(t)\delta(t-T) = \phi(T)\delta(t-T)$$

- Sampling property of the unit function

$$\int_{-\infty}^{+\infty} \phi(t)\delta(t)dt = \int_{-\infty}^{+\infty} \phi(0)\delta(t)dt = \phi(0) \int_{-\infty}^{+\infty} \delta(t)dt = \phi(0)$$

$$\int_{-\infty}^{+\infty} \phi(t)\delta(t-T)dt = \phi(T)$$

- The area under the curve obtained by the product of the unit impulse function shifted by T and $\phi(t)$ is the value of the function $\phi(t)$ for $t=T$

Properties of the unit impulse function

- The unit step function is the integral of the unit impulse function

$$\frac{du}{dt} = \delta(t)$$

$$\int_{-\infty}^t \delta(t) dt = u(t)$$

– Thus

$$\int_{-\infty}^t \delta(t) dt = u(t) = \begin{cases} 0 & t < 0 \\ 1 & t \geq 0 \end{cases}$$

Properties of the unit impulse function

- Discrete time impulse function

$$\delta [n] = \begin{cases} 1 & \text{if } n = 0 \\ 0 & \text{otherwise} \end{cases}$$

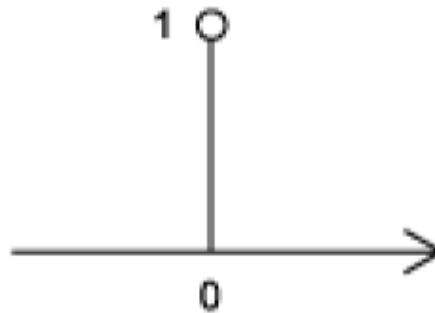

Useful functions

- Continuous time complex exponential

$$f(t) = Ae^{j\omega t}$$

- Euler's relations

$$Ae^{j\omega t} = A\cos(\omega t) + j(A\sin(\omega t))$$

$$\cos(\omega t) = \frac{e^{j\omega t} + e^{-j\omega t}}{2}$$

$$\sin(\omega t) = \frac{e^{j\omega t} - e^{-j\omega t}}{2j}$$

$$e^{j\omega t} = \cos(\omega t) + j\sin(\omega t)$$

- Discrete time complex exponential

– $k=nT$

$$\begin{aligned} f[n] &= Be^{snT} \\ &= Be^{j\omega nT} \end{aligned}$$

Useful functions

- Exponential function e^{st}
 - Generalization of the function $e^{j\omega t}$

$$s = \sigma + j\omega$$

Therefore

$$e^{st} = e^{(\sigma+j\omega)t} = e^{\sigma t} e^{j\omega t} = e^{\sigma t} (\cos \omega t + j \sin \omega t) \quad (1.30a)$$

If $s^* = \sigma - j\omega$ (the conjugate of s), then

$$e^{s^*t} = e^{\sigma-j\omega t} = e^{\sigma t} e^{-j\omega t} = e^{\sigma t} (\cos \omega t - j \sin \omega t) \quad (1.30b)$$

and

$$e^{\sigma t} \cos \omega t = \frac{1}{2}(e^{st} + e^{s^*t}) \quad (1.30c)$$

The exponential function

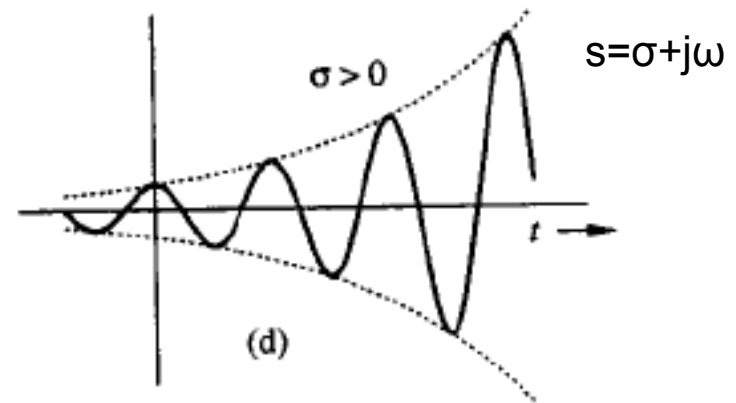
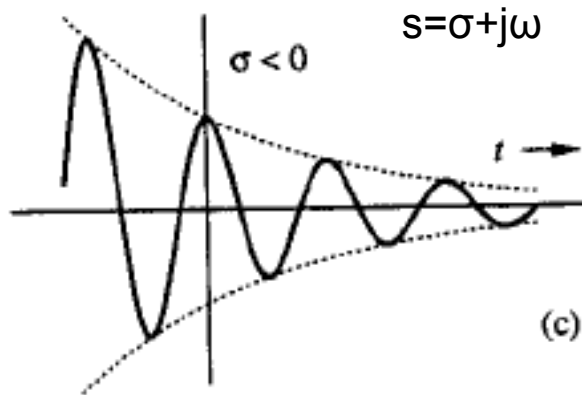
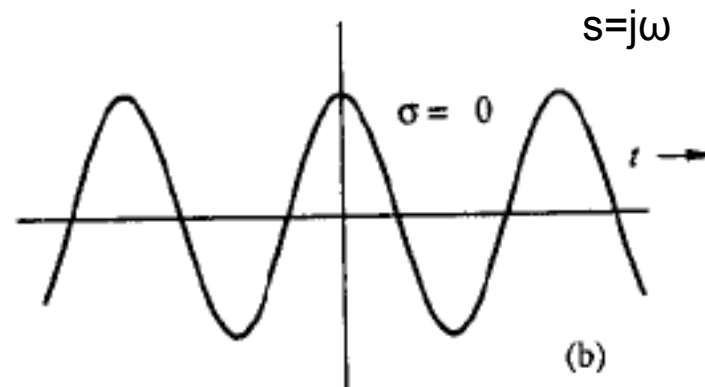
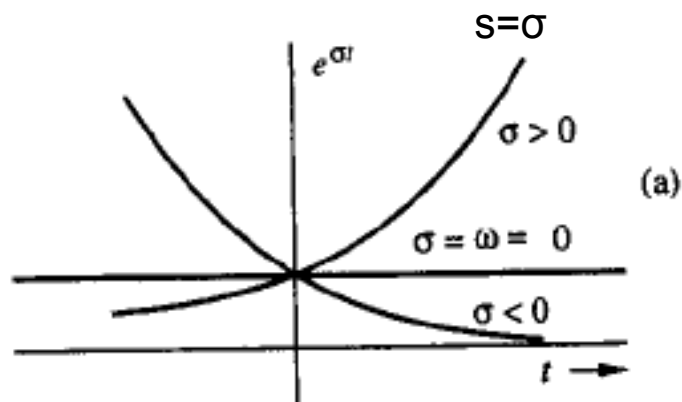

Complex frequency plan

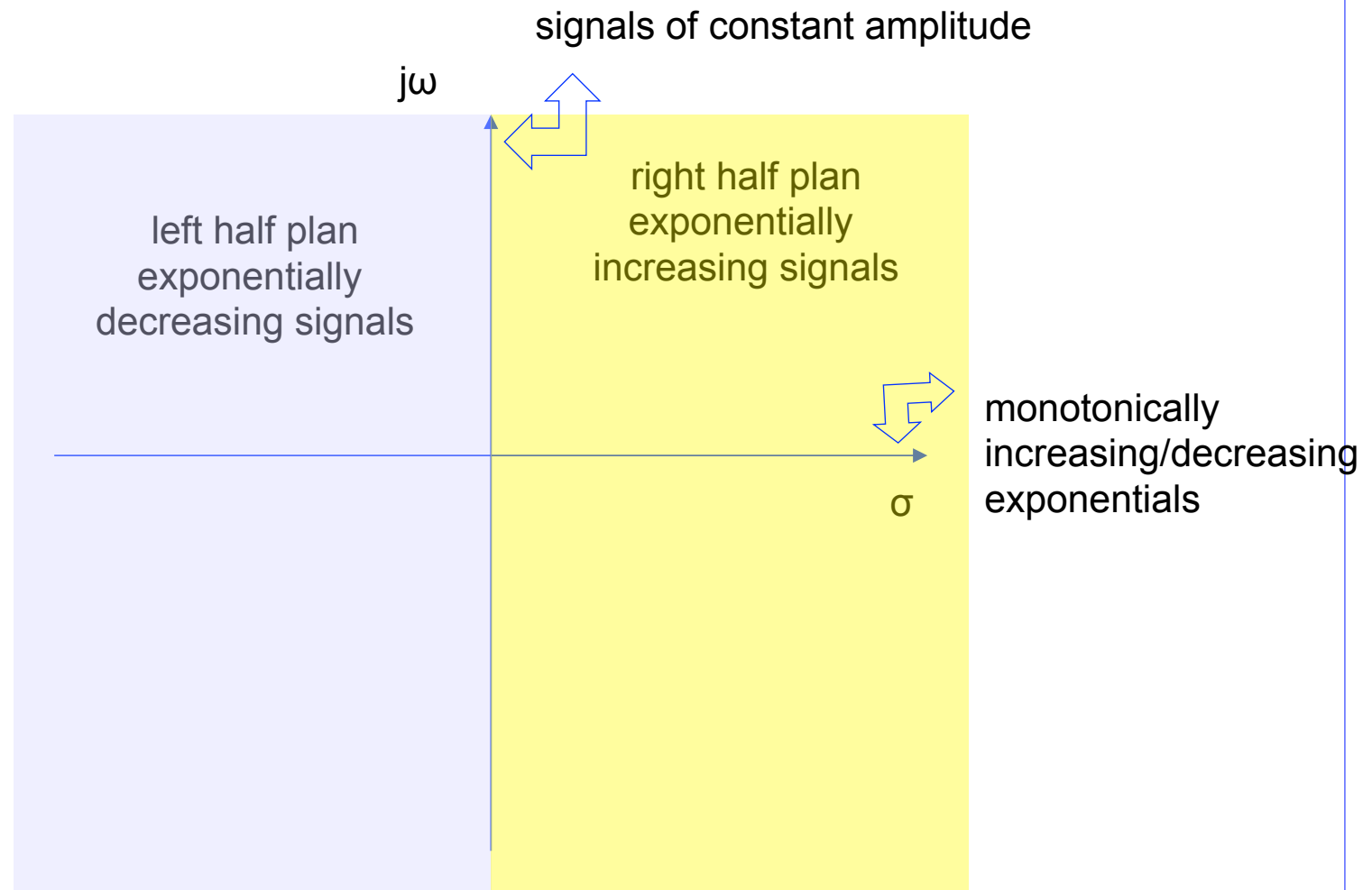

Basics of Linear Systems

2D Linear Systems

Systems

- A system is characterized by
 - inputs
 - outputs
 - rules of operation (mathematical model of the system)

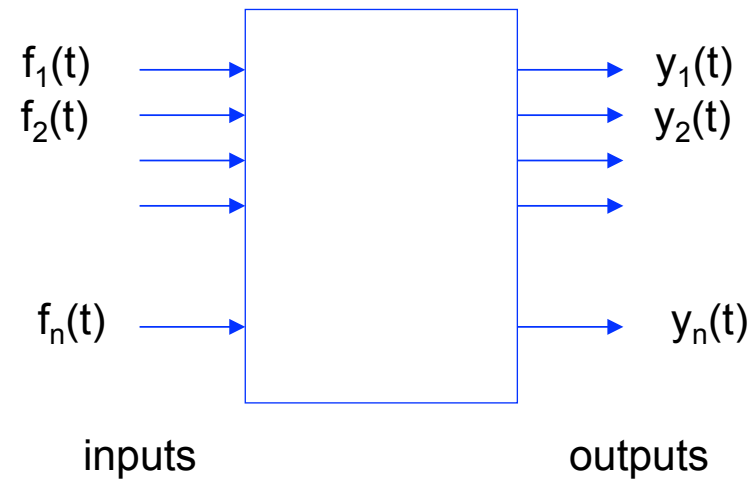

Systems

- Study of systems: mathematical modeling, analysis, design
 - Analysis: how to determine the system output given the input and the system mathematical model
 - design or synthesis: how to design a system that will produce the desired set of outputs for given inputs
- SISO: single input single output - MIMO: multiple input multiple output

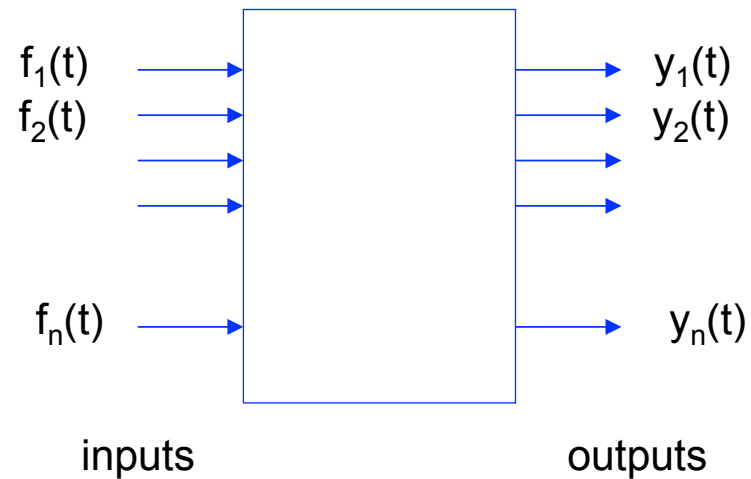
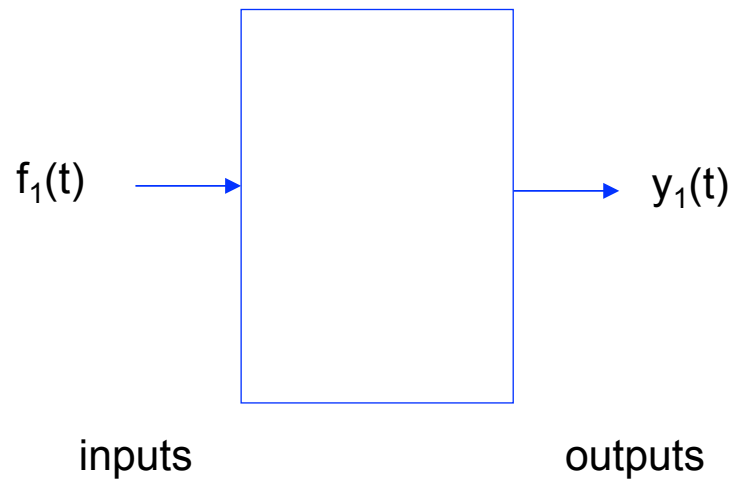

Response of a linear system

- Total response = Zero-input response + Zero-state response
 - The output of a system for $t \geq 0$ is the result of two independent causes: the initial conditions of the system (or system state) at $t=0$ and the input $f(t)$ for $t \geq 0$.
 - Because of linearity, the total response is the sum of the responses due to those two causes
 - The zero-input response is only due to the initial conditions and the zero-state response is only due to the input signal
 - This is called decomposition property
- Real systems are *locally* linear
 - Respond linearly to small signals and non-linearly to large signals

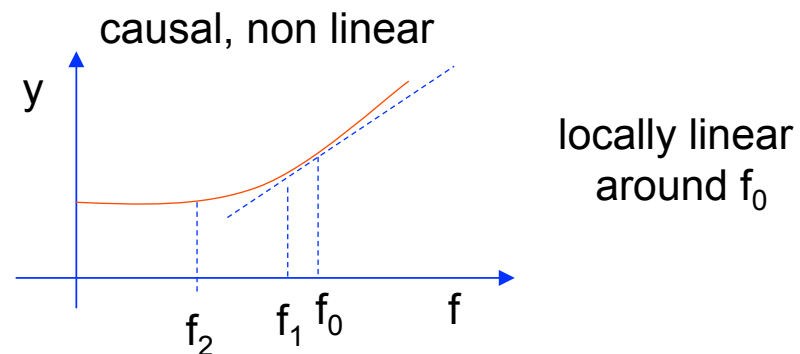
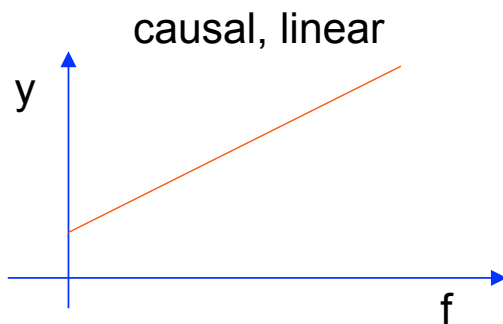

Review: Linear Systems

- We define a system as a unit that converts an input function into an output function

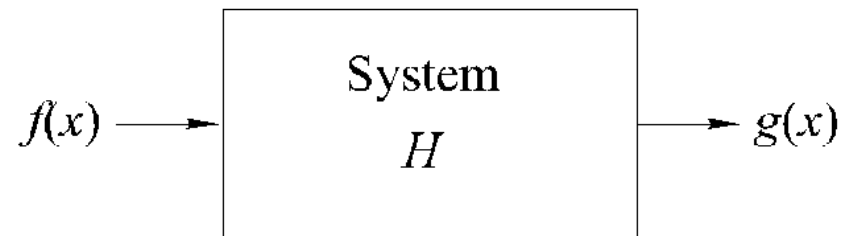

$$g(x) = H[f(x)]$$

Independent System operator or Transfer function variable

Linear Time Invariant Discrete Time Systems

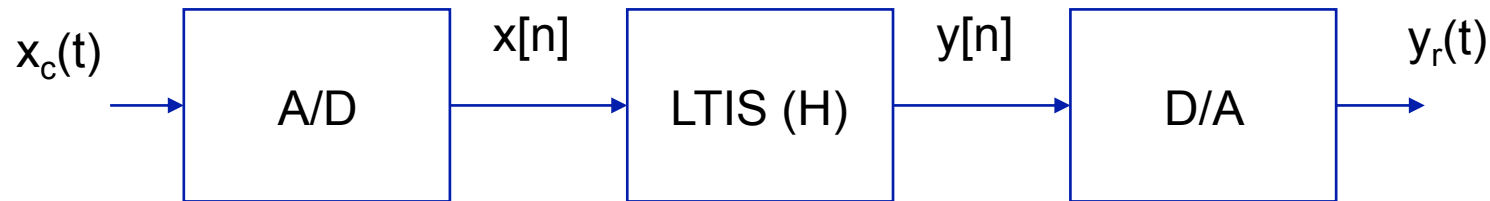

$$Y(e^{j\omega}) = H(e^{j\omega})X(e^{j\omega})$$

$$Y_r(j\Omega) = H(j\Omega)X_c(j\Omega)$$

$$H(j\Omega) = \begin{cases} H(j\Omega) & |\Omega| < \pi/T \\ 0 & |\Omega| \geq \pi/T \end{cases}$$

IF

- The input signal is bandlimited
- The Nyquist condition for sampling is met
- The digital system is linear and time invariant

THEN

The overall continuous time system is equivalent to a LTIS whose frequency response is H.

Overview of Linear Systems

- Let

$$g_i(x) = H[f_i(x)]$$

where $f_i(x)$ is an arbitrary input in the class of all inputs $\{f(x)\}$, and $g_i(x)$ is the corresponding output.

- If

$$\begin{aligned} H[a_i f_i(x) + a_j f_j(x)] &= a_i H[f_i(x)] + a_j H[f_j(x)] \\ &= a_i g_i(x) + a_j g_j(x) \end{aligned}$$

Then the system H is called a *linear system*.

- A linear system has the properties of *additivity* and *homogeneity*.

Linear Systems

- The system H is called *shift invariant* if

$$g_i(x) = H[f_i(x)] \text{ implies that } g_i(x + x_0) = H[f_i(x + x_0)]$$

for all $f_i(x) \in \{f(x)\}$ and for all x_0 .

- This means that offsetting the independent variable of the input by x_0 causes the same offset in the independent variable of the output. Hence, the input-output relationship remains the same.

Linear Systems

- The operator H is said to be *causal*, and hence the system described by H is a *causal system*, if there is no output before there is an input. In other words,

$$f(x) = 0 \text{ for } x < x_0 \text{ implies that } g(x) = H[f(x)] = 0 \text{ for } x < x_0.$$

- A linear system H is said to be *stable* if its response to any bounded input is bounded. That is, if

$$|f(x)| < K \text{ implies that } |g(x)| < cK$$

where K and c are constants.

Linear Systems

- A *unit impulse function*, denoted $\delta(a)$, is *defined* by the expression

$$\int_{-\infty}^{\infty} f(a)\delta(x-a)da = f(x).$$

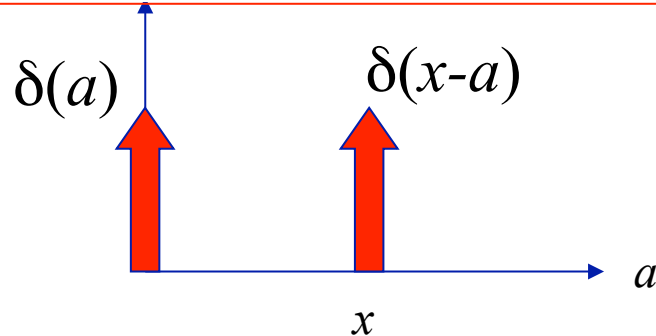

- The response of a system to a unit impulse function is called the *impulse response* of the system.

$$h(x) = H[\delta(x)]$$

Linear Systems

- If H is a linear shift-invariant system, then we can find its response to any input signal $f(x)$ as follows:

$$g(x) = \int_{-\infty}^{\infty} f(\alpha)h(x - \alpha)d\alpha.$$

- This expression is called the *convolution integral*. It states that the response of a linear, fixed-parameter system is completely characterized by the convolution of the input with the system impulse response.

Linear Systems

- Convolution of two functions of a continuous variable is defined as

$$f(x) * h(x) = \int_{-\infty}^{\infty} f(\alpha)h(x - \alpha)d\alpha$$

- In the discrete case

$$f[n] * h[n] = \sum_{m=-\infty}^{\infty} f[m]h[n - m]$$

Linear Systems

- In the 2D discrete case

$$f[n_1, n_2] * h[n_1, n_2] = \sum_{m_1=-\infty}^{\infty} \sum_{m_2=-\infty}^{\infty} f[m_1, m_2] h[n_1 - m_1, n_2 - m_2]$$

$h[n_1, n_2]$ is a linear filter.

Illustration of the folding, displacement, and multiplication steps needed to perform two-dimensional convolution

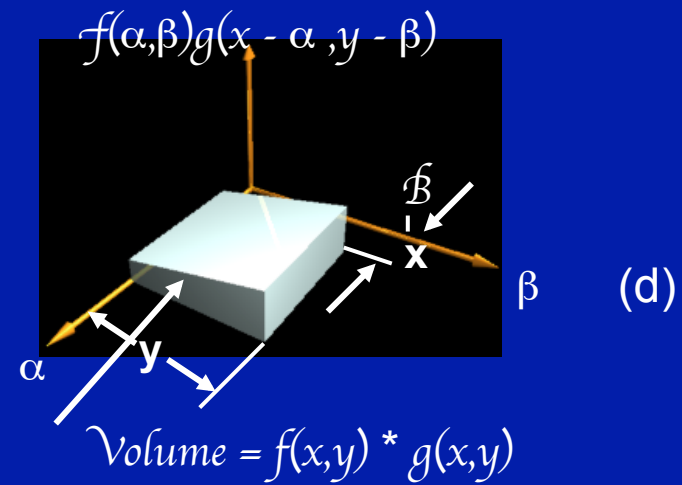
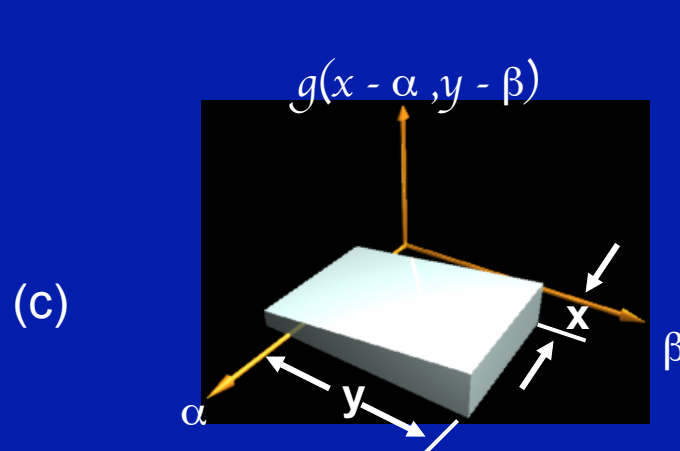
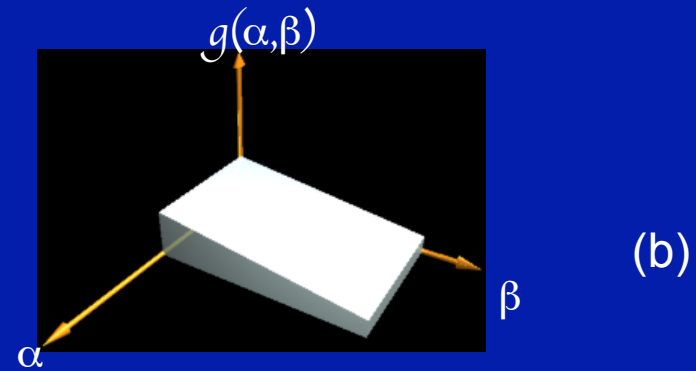
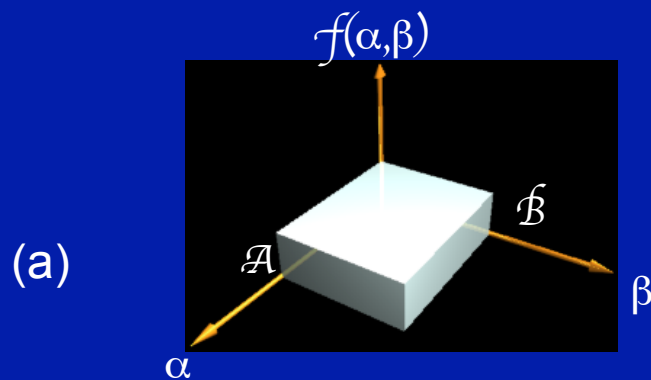

Matrix perspective

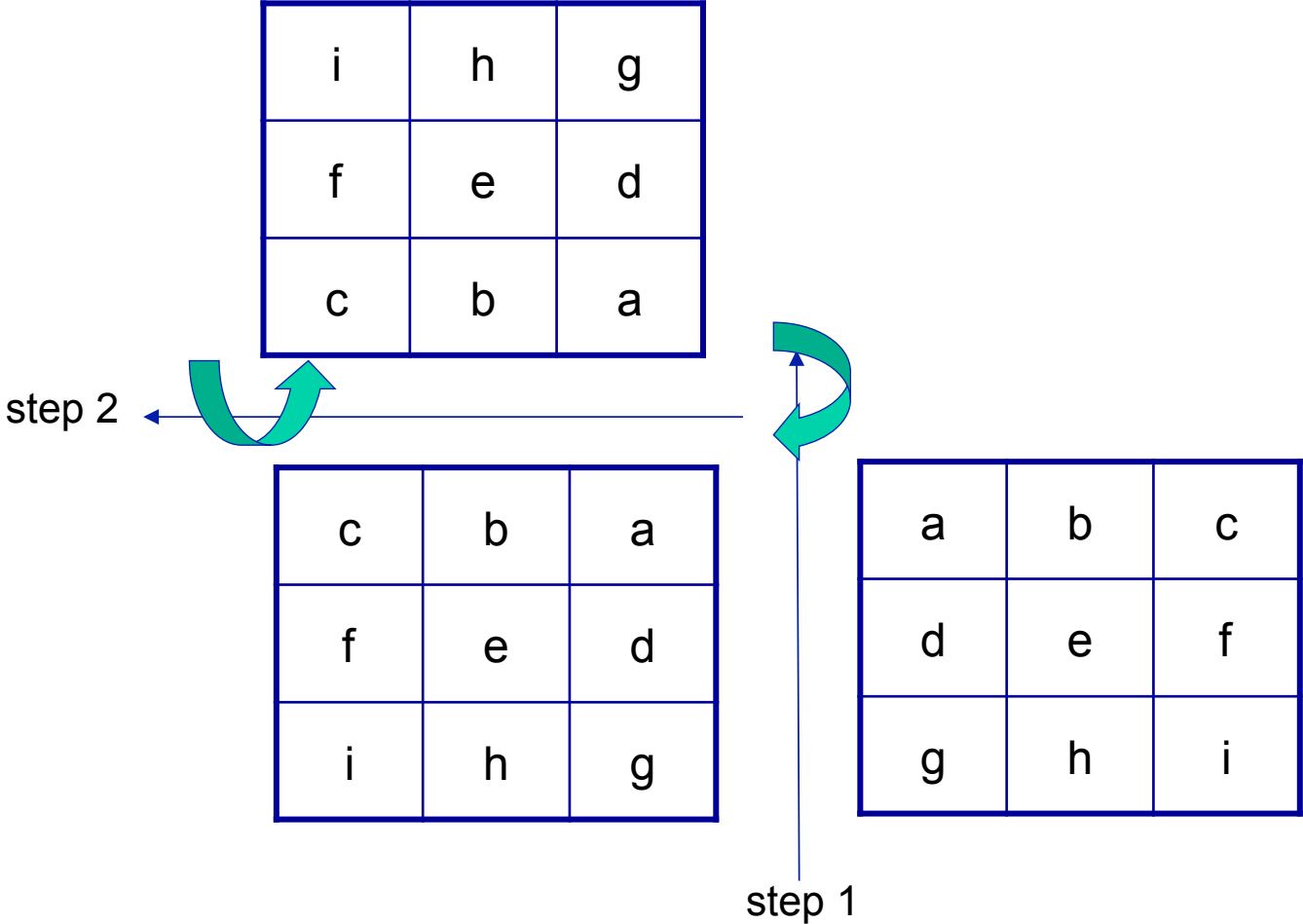

Convolution Example

h

1	-1	-1
1	2	-1
1	1	1

Rotate



1	1	1
-1	2	1
-1	-1	1

$$f[n_1, n_2] ** h[n_1, n_2] = \sum_{m_1=-\infty}^{\infty} \sum_{m_2=-\infty}^{\infty} f[m_1, m_2] h[n_1 - m_1, n_2 - m_2]$$

f

2	2	2	3
2	1	3	3
2	2	1	2
1	3	2	2

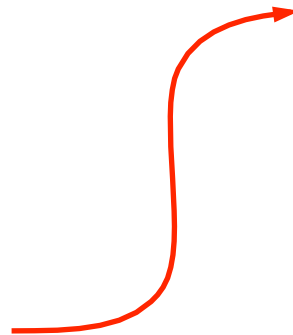

From C. Rasmussen, U. of Delaware

Convolution Example

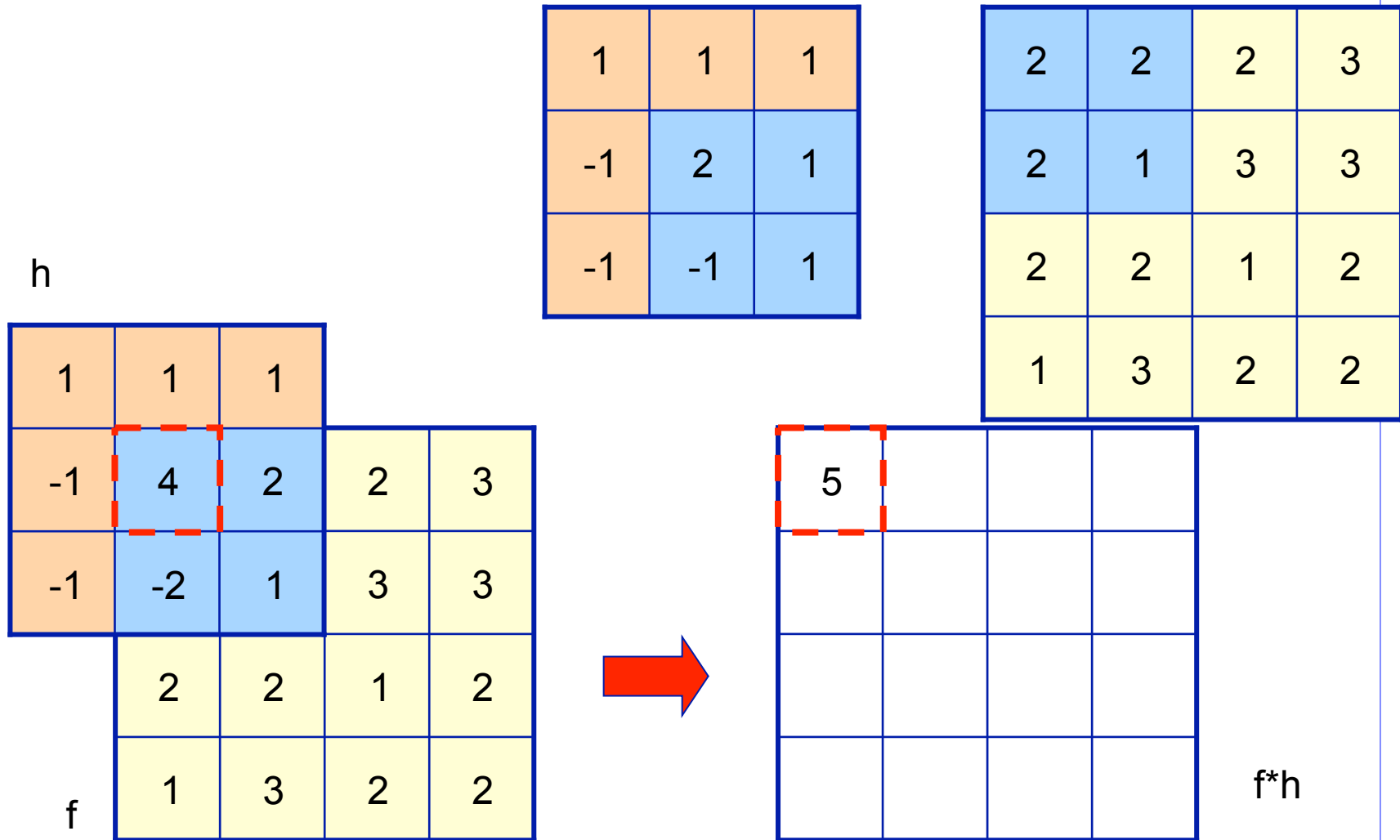

Convolution Example

h

1	1	1
-1	2	1
-1	-1	1

2	2	2	3
2	1	3	3
2	2	1	2
1	3	2	2

1	1	1	
-2	4	2	3
-2	-1	3	3
2	2	1	2
1	3	2	2

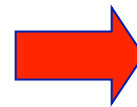

5	4		

f*h

Convolution Example

1	1	1
-1	2	1
-1	-1	1

2	2	2	3
2	1	3	3
2	2	1	2
1	3	2	2

h

	1	1	1
2	-2	4	3
2	-1	-3	3
2	2	1	2
1	3	2	2

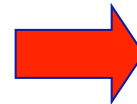

5	4	4	

Convolution Example

1	1	1
-1	2	1
-1	-1	1

2	2	2	3
2	1	3	3
2	2	1	2
1	3	2	2

		1	1	1
2	2	-2	6	1
2	1	-3	-3	1
2	2	1	2	
1	3	2	2	

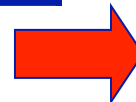

5	4	4	-2

Convolution Example

1	1	1
-1	2	1
-1	-1	1

2	2	2	3
2	1	3	3
2	2	1	2
1	3	2	2

h

1	2	2	2	3
-1	4	1	3	3
-1	-2	2	1	2
	1	3	2	2

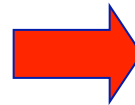

5	4	4	-2
9			

80

f

f*h

Convolution Example

1	1	1
-1	2	1
-1	-1	1

2	2	2	3
2	1	3	3
2	2	1	2
1	3	2	2

h

2	2	2	3
-2	2	3	3
-2	-2	1	2
1	3	2	2

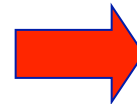

5	4	4	-2
9	6		