



Medium Access Control in Wireless Sensor Networks

Davide Quaglia, Damiano Carra



LIVELLO DATALINK



Goals

- Reliable and efficient communication between two nodes on the same physical medium
 - Cable (Wired)
 - Wireless
- Assumptions from the lower physical layer:
 - The concept of *bit* is defined
 - Bits, if received, arrive in the same order in which they have been transmitted

3



Functionality

- *Framing* = Bit grouping into layer-2 PDUs
- Error checking
- Ack and retransmission of corrupted/lost PDUs (not in all protocols)
- Policy of use of the channel if more than 2 nodes share the same physical medium
 - Node addressing
 - Channel arbitration

4



Services provided to the upper network layer

- Un-acknowledged connection-less service (e.g. Ethernet/IEEE802.3)
- Acknowledged connection-less service (e.g. WiFi/IEEE802.11, IEEE802.15.4)
- Connection-oriented service (e.g. IEEE802.16)
- REMARK: the connection-oriented service is also acknowledged and furthermore it provides flow control

5



Framing

- Improve channel utilisation in case of more than two nodes sharing it
- Requested to check errors and recover PDUs
 - Error detection must be performed on blocks of bits (e.g. CRC)
 - The corrupted PDU can be retransmitted
- Issue: definition of start/end of frame

6

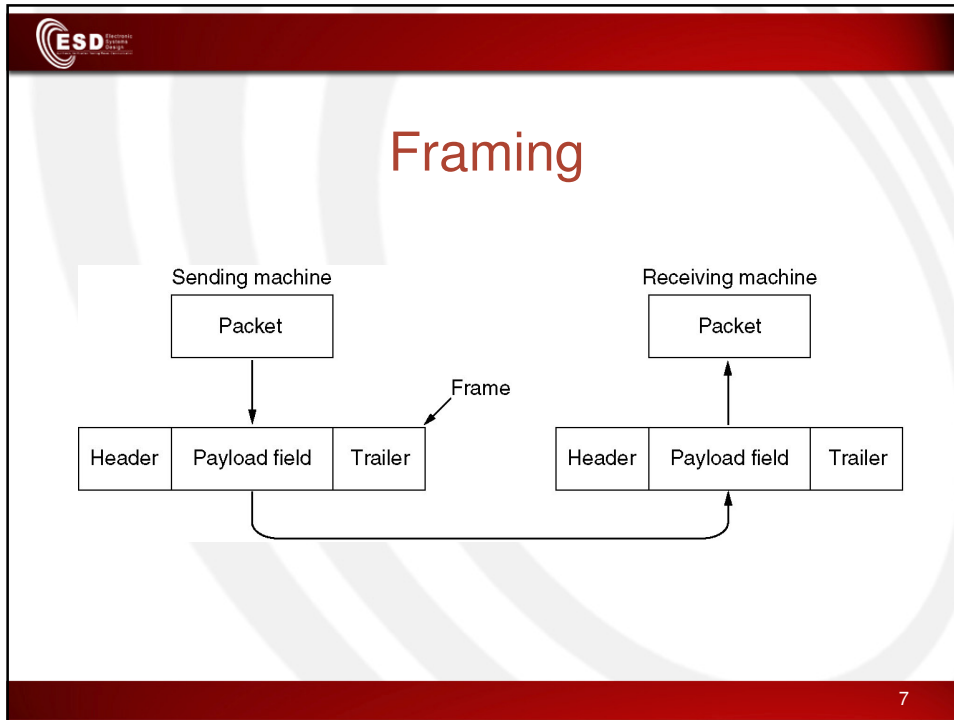

ESD Elements of Data Communication

Start/end of frame

- We need to use symbols which are not used to send data otherwise a sequence of data bits could be considered erroneously a start/end of frame
 - Physical signal configurations which are not used for data bits
 - Specific configuration choices can improve bit synchronization between TX and RX
 - Particular sequence of data bit values (FLAG)
 - Bit stuffing/de-stuffing is needed to avoid FLAG simulation in the PDU
 - Inter-packet gap minimum between 2 consecutive frames

8



Bit stuffing/de-stuffing

- Example taken from HDLC protocol
- Byte 01111110 is used as FLAG at the beginning/end of each frame
- The bits of the original frame are modified through *stuffing*
 - After five “1”s a “0” is automatically inserted
- At the receiver the Data Link layer operates de-stuffing

9



Bit stuffing: example

(a) 0110111111111111111111110010

(b) 01101111101111110111111010010

Stuffed bits

(c) 0110111111111111111111110010

- Original data from upper layer
- Data transmitted on the wire or over-the-air
- Data at the receiver after de-stuffing.

10



Error detection

- Some bits may have incorrect values at the RX
 - Interference, low-level signal
 - Often errors are not isolated but group into *burst*
- Hamming distance
- Redundant information must be added to the message to check errors
 - m bits of the original message
 - r bits of the code for error detection
 - $n=m+r$ bits transmitted on the channel
 - Code rate = m/n
- Examples
 - Parity Bit
 - Checksum
 - Circular Redundancy Check (CRC)

11



Parity bit

- At the TX a bit is appended to the message
 - “1” if the amount of “1” in the message is even
 - “0” if the amount of “1” in the message is odd
- At the RX if the amount of “1” is even then at least one bit flipped its values
 - One bit or an odd number of bits (we cannot distinguish)
 - Errors affecting an even number of bits are not detected

12



Check sum

- Extension of the concept of parity bit
- The message is decomposed into r bit words
- The words are summed and overflow is not taken into account
- The sum (another r -bit word) is appended to the message
- The sum is recomputed at the RX
 - If it is different from the appended value an error occurred
- Errors are not detected if they affect different bits that do not change the sum

13



Circular Redundancy Check (CRC)

- The message is seen as the coefficients vector of a polynomial $M(x)$ having degree $m-1$
- Let $R(x)$ be the remainder of the polynomial division $x^r M(x)/G(x)$ where $G(x)$ is named *generating polynomy*
- By construction the polynomial $x^r M(x) - R(x)$ is exactly divided by $G(x)$ and it is transmitted on the channel ($m+r$ bit)
- At RX if the received sequence of bits is exactly divided by $G(x)$ then it is considered correct

14

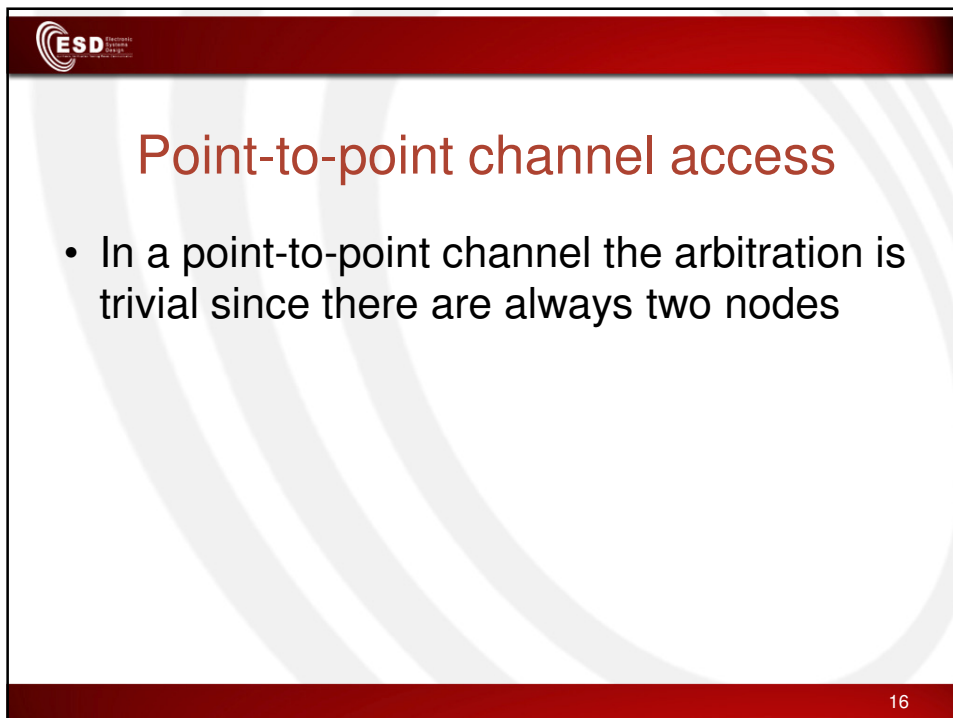
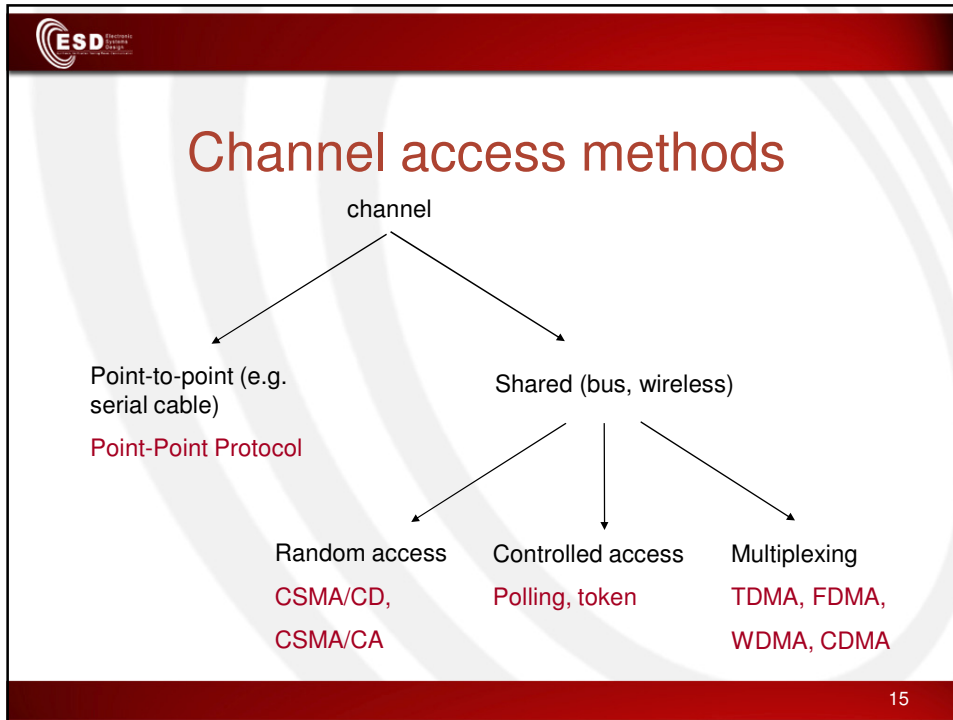



Limit of the point-to-point architecture

- In case of N nodes the number of point-to-point channels is $N(N-1)$ with a quadratic cost increase
- A shared channel is needed

17



Access in case of shared channel

- Random access: the node which wants to transmit must wait for the channel to be free (carrier sense)
- Controlled access:
 - Polling: a master asks to each other node if it has something to transmit
 - Token: a token moves among the nodes; the node with the token can transmit for a given amount of time

18



Access in case of shared channel (2)

- Multiplexing: the physical channel is de-composed into logical channels used by nodes pairs as they were point-to-point channels
- De-composition methodology:
 - Radio frequency for wireless (Frequency Division Multiplexing o FDM) o light color for optical fibers (Wavelength Division Multiplexing o WDM)
 - Time interval (Time Division Multiplexing – TDM)
 - Frequency+time (Code Division Multiplexing – CDM)
 - 3G mobile and beyond

19



Problems in case of wireless transmission

- Interference and path loss
 - Non-negligible bit error rate
- Collision management more complex
 - Hidden node
 - Exposed Node

20



Interference and path loss

- More devices use the same frequency band (since it is un-licensed)
 - Other wireless nodes
 - Remote controls
 - Microwave ovens
- The signal energy decreases as a function of the distance between TX and RX
- Obstacles (e.g., walls)
- Multiple reflections of the signal cause signal distortion

21



Correct frame probability

- Probability to receive a correct bit

$$(1 - P_{bit}^{error})$$
- Probability to receive a PDU of length N

$$P_{ok}^{frame} = (1 - P_{bit}^{error})^N$$
 - E.g., N = 1518 byte = 12144 bit
- Caso Ethernet $P_{bit}^{error} = 10^{-10} \Rightarrow P_{ok}^{frame} = 0.9999988$
- Caso WiFi $P_{bit}^{error} = 10^{-4} \Rightarrow P_{ok}^{frame} = 0.2968700$

22

ESD Elements of Systems Design

Limits of carrier sense: Hidden node and exposed node

A wants to send to B
but cannot hear that
B is busy

B wants to send to C
but mistakenly thinks
the transmission will fail

(a) Hidden node
b) Exposed node

23

ESD Elements of Systems Design

Limit of collision detection (CSMA/CD)

- Collision Detection phase of CSMA/CD is not suitable
 - A double radio interface (to send and sense concurrently) is expensive...
 - ... and useless since most of the collisions happen at the receiver
- --> Collision Avoidance
- --> Stop&Wait ack

24



CSMA/CA

- Carrier sense
- Collision avoidance via random back-off
- [optional] RTS/CTS

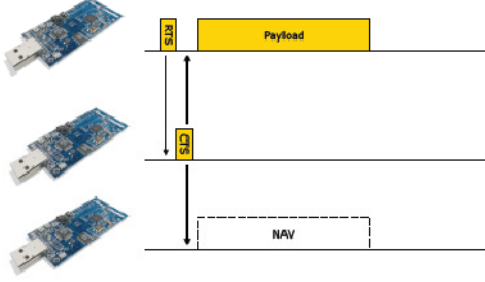

25



MEDIUM ACCESS CONTROL FOR WSN

26



MAC Challenges

- Traditionally
 - Fairness
 - Latency
 - Throughput
- For Sensor Networks
 - Power efficiency
 - Scalability

27



Power consumption of carrier sense

- Expected life time of many WSN applications:
Months or years
 - Actual lifetime
 - AA batteries: Max. 2000 mAh
 - CC2430 radio: 26.7mA in RX mode
 - $2000\text{mAh} / 26.7\text{mA} = 75 \text{ hours} = 3 \text{ days}$
- Keep radio asleep most of the time
- Ideal duty cycle: 0.1% - 1%

28

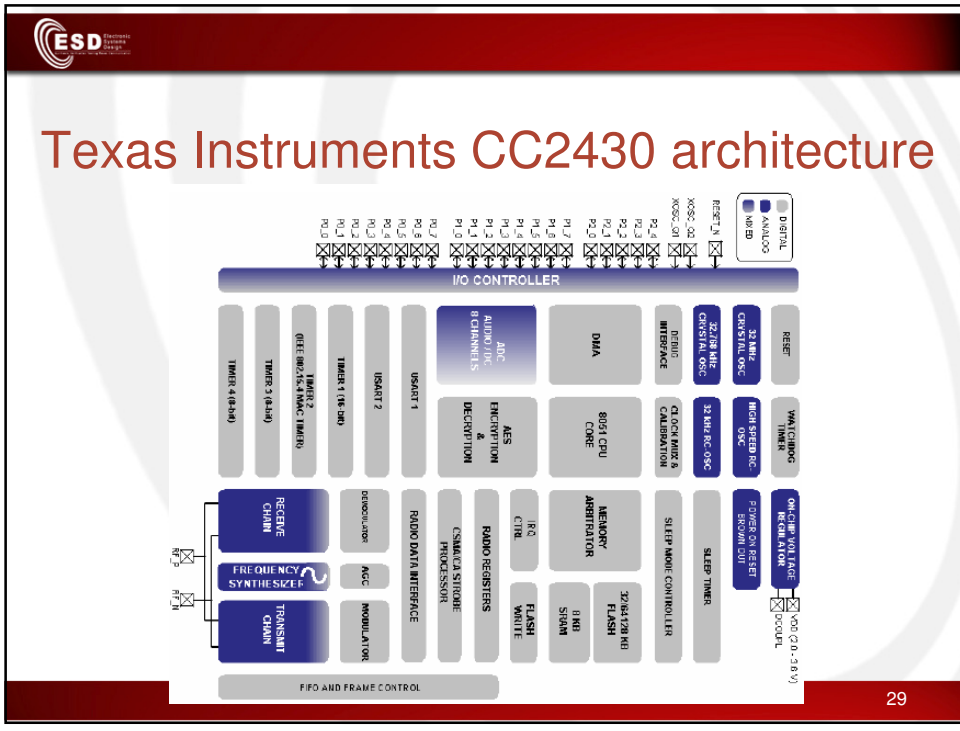

Power modes in TI CC2430

MCU Active Mode, 16 MHz	4.3	mA	Digital regulator on, High frequency (16 MHz) RCOSC running. No radio, crystals, or peripherals active.
MCU Active Mode, 32 MHz	9.5	mA	MCU running at full speed (32MHz), 32MHz XOSC running. No radio or peripherals active.
MCU Active and RX Mode	26.7	mA	MCU running at full speed (32MHz), 32MHz XOSC running, radio in RX mode, -50 dBm input power. No peripherals active.
MCU Active and TX Mode, 0dBm	28.1	mA	MCU running at full speed (32MHz), 32MHz XOSC running, radio in TX mode, 0dBm output power. No peripherals active.
Power mode 1	190	μA	Digital regulator on, High frequency RCOSC and crystal oscillator off. 32.768 kHz XOSC, POR and ST active. RAM retention.
Power mode 2	0.5	μA	Digital regulator off, High frequency RCOSC and crystal oscillator off. 32.768 kHz XOSC, POR and ST active. RAM retention.
Power mode 3	0.3	μA	No clocks. RAM retention. POR active.

Time-out

Interrupt

				
Power modes in TI CC2430				
MCU Active Mode, 16 MHz		4.3	mA	Digital regulator on, High frequency (16 MHz) RCOSC running. No radio, crystals, or peripherals active.
MCU Active Mode, 32 MHz		9.5	mA	MCU running at full speed (32MHz), 32MHz XOSC running. No radio or peripherals active.
MCU Active and RX Mode		26.7	mA	MCU running at full speed (32MHz), 32MHz XOSC running, radio in RX mode, -50 dBm input power. No peripherals active.
MCU Active and TX Mode, 0dBm		28.1	mA	MCU running at full speed (32MHz), 32MHz XOSC running, radio in TX mode, 0dBm output power. No peripherals active.
Power mode 1		190	μA	Digital regulator on, High frequency RCOSC and crystal oscillator off. 32.768 kHz XOSC, POR and ST active. RAM retention.
Power mode 2		0.5	μA	Digital regulator off, High frequency RCOSC and crystal oscillator off. 32.768 kHz XOSC, POR and ST active. RAM retention.
Power mode 3		0.3	μA	No clocks. RAM retention. POR active.

31

	
Example of power-efficient MAC	
• 1 s in sleep mode (power mode 2) → 0.5 μA	
• 0.005 s in RX mode for carrier sense → 26.7 mA	
• 0.005 s in TX mode to send packet → 28.1 mA	
• Weighted current consumption	
– $(0.0005 \cdot 1000 + 26.7 \cdot 5 + 28.1 \cdot 5) / (1010) \sim 0.27 \text{ mA}$	
• With AA batteries: 2000mAh / 0.27 mA ~ 7359 hours ~ 307 days	

32



Sources of energy waste

- Collision
 - Retransmissions
- Idle listening
 - Continuously sense the channel
- Overhearing
 - Listen to packets addressed to other nodes
- Packet overhead
 - Header
 - Control packets (e.g., RTS/CTS)

33



Power Save Design Alternatives

- Wake-up radio
 - A sleeping node can be woken at any time by a secondary receiver (wake-up radio)
- Asymmetric polling
- Timer-Based
 - When a node enters sleep mode, it sets a timer to wakeup at a pre-determined time
- Hybrid
 - Timer-Based plus Wake-up radio

34



Wake-up radio

- Add second, low-power receiver to wakeup the main system on-demand
- Low-power could be achieved by:
 - Simpler hardware with a lower bit-rate and/or less decoding capability
 - Periodic listening using a radio with identical physical layer as data radio

35



Wake-up radio

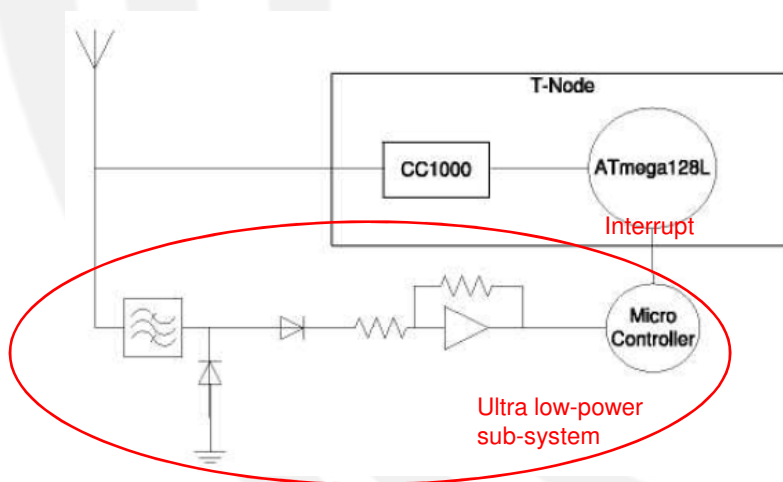

36

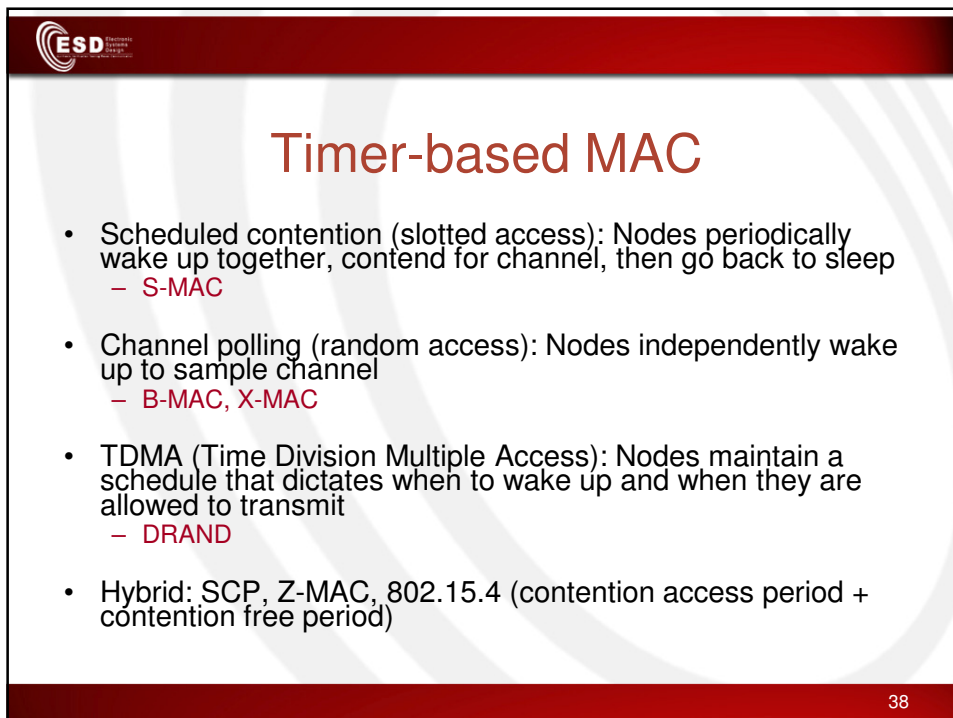
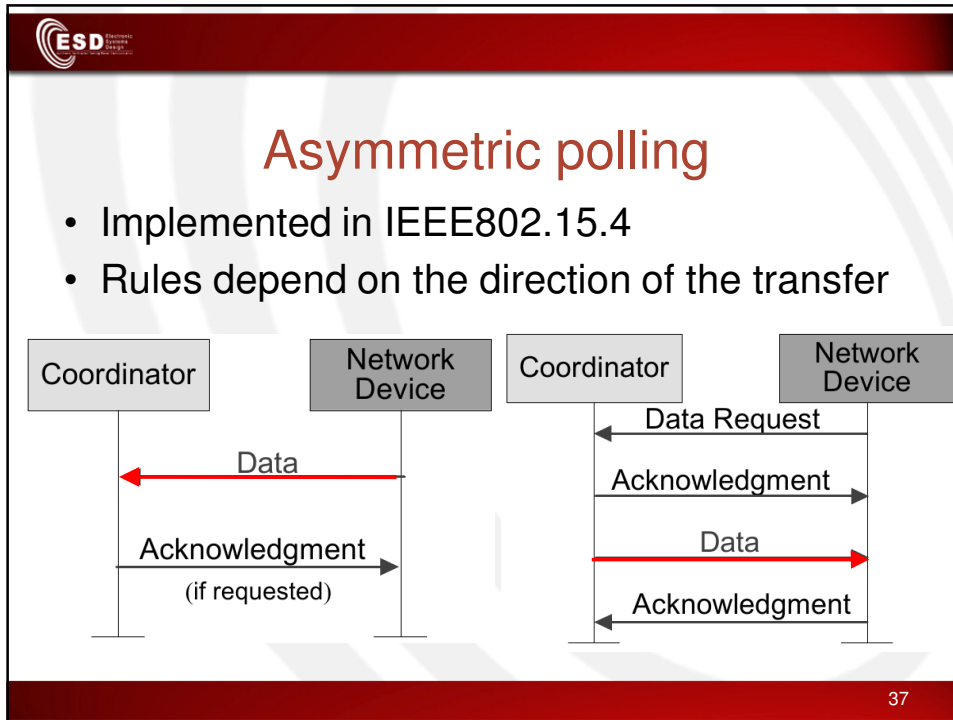



S-MAC (Sensor MAC)

- A node sleeps most of the time
- Periodically wake up for short intervals to see if any node is transmitting a packet
- Accept latency to extend lifetime

39



S-MAC: SYNC interval

- Listen time consists of two parts: SYNC and RTS
- In the SYNC interval some nodes periodically send SYNC packet to synchronize clocks
- They use CSMA/CA for channel contention

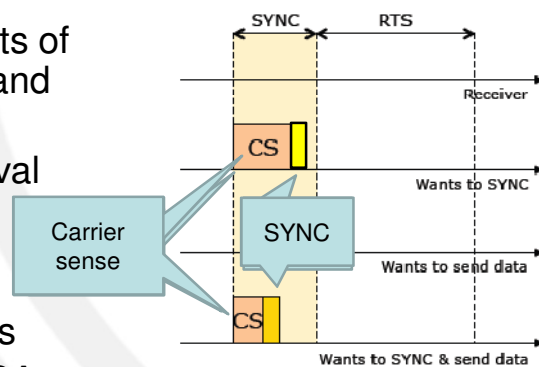

C. Lu, Washington Univ. Saint Louis

40



S-MAC: RTS interval

- RTS/CTS is used to transmit data
- CSMA/CA followed by RTS/CTS

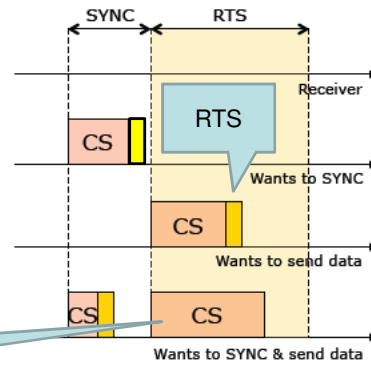

C. Lu, Washington Univ. Saint Louis

41



S-MAC: data transmission

- RTS/CTS contain the expected data TX time
 - Listeners not interested can sleep to save energy
- Sender does one RTS/CTS and then sends data for the rest of the frame
 - Prefer application performance to node level fairness
- ACK every data packet
 - Packet fragmentation for higher reliability

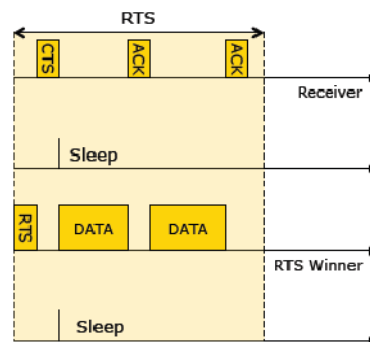

C. Lu, Washington Univ. Saint Louis

42



Pros and Cons of S-MAC

- More power conserving than standard CSMA/CA
- During the listening interval, everyone needs to stay awake unless someone transmits
 - Waste energy
- Time sync overhead
- RTS/CTS/ACK overhead
- Complex to be implemented

43



B-MAC (Berkeley MAC)

- Low Power Listening (LPL)
 - Periodic preamble sampling \rightarrow Preamble $>$ Sleep period
 - No sync between nodes
- Hidden terminal avoidance and multi-packet mechanisms not provided

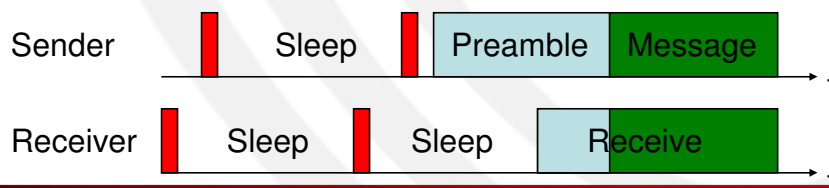

44



Pros and Cons of B-MAC

- No need for everybody to stay awake when there is no traffic
 - Just wake up for preamble sampling and go back to sleep
- Better power conservation, latency and throughput than S-MAC
- Simpler to implement
- Low duty cycle → longer preamble
 - Little cost to receiver yet higher cost to sender
 - Longer delay
 - More contention

45



X-MAC: Early ACK

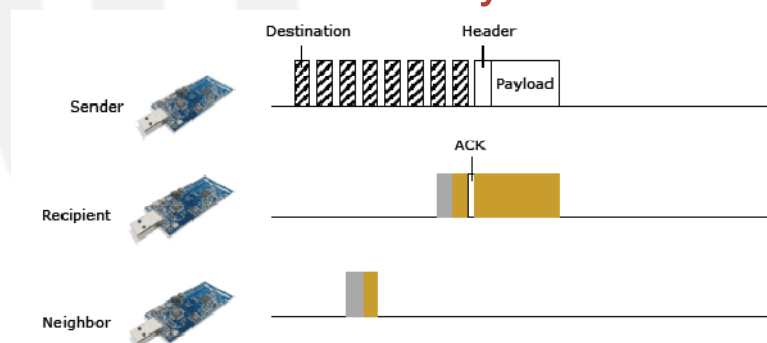

- Include destination address in short preambles
- Non-receiver avoids overhearing
- Receiver acknowledges preamble → Sender stops sending preamble

46



Thoughts on X-MAC

- Better than B-MAC in terms of latency, throughput and power consumption
- Energy consumption due to overhearing reduced
- Simple to implement
- On average the preamble size is reduced by half compared to B-MAC → Still considerable overhead

47



SCP-MAC

- Scheduled Channel Polling by everybody
 - Avoid long preambles in LPL (Low Power Listening) supported by B-MAC
- Wake up tone
 - Much shorter than preamble in LPL followed by data
- Assumption: the listening intervals must be synchronized

48

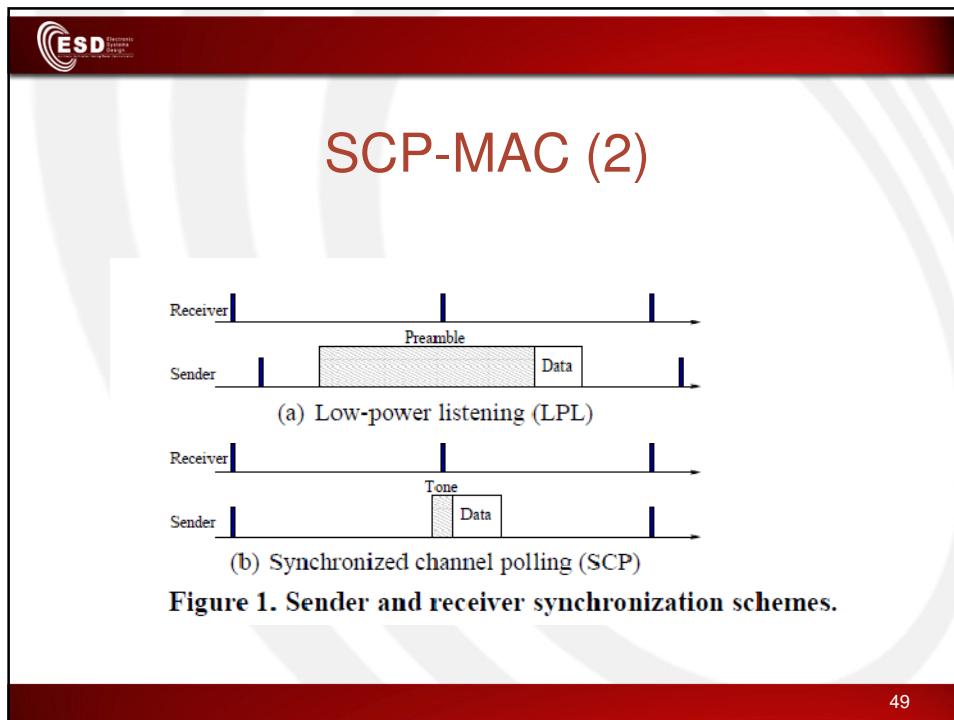

Time Division Multiple Access (TDMA)

- Predictable delay, throughput and duty cycle
- Little packet losses due to contention
- Scheduling and time sync are difficult
- Slots are wasted when a node has nothing to send

50

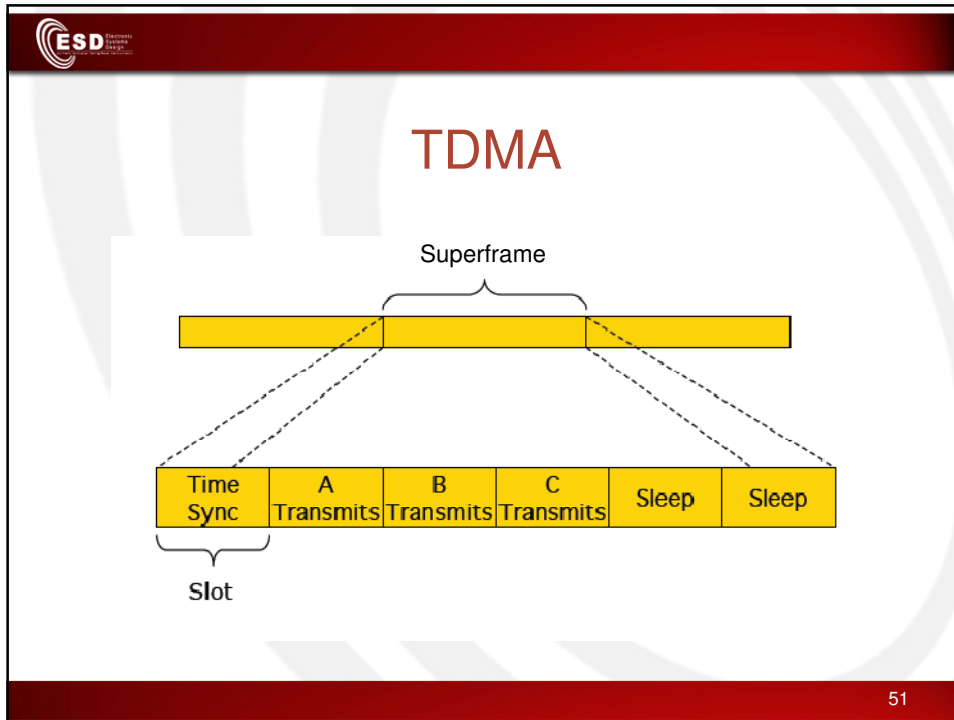

51

Z-MAC (Zebra MAC)

- Runs on top of B-MAC
- Rely on CSMA under light load → Switch to TDMA under high contention

52



Z-MAC (Zebra MAC)

CSMA	TDMA
<ul style="list-style-type: none"> • Pros <ul style="list-style-type: none"> – Simple – Scalable • Cons <ul style="list-style-type: none"> – Collisions due to hidden terminals – RTS/CTS is overhead 	<ul style="list-style-type: none"> • Pros <ul style="list-style-type: none"> – Naturally avoids collisions • Cons <ul style="list-style-type: none"> – Complexity of scheduling – Synchronization needed

53



Thoughts on Z-MAC

- Good idea to combine strengths of CSMA and TDMA
- Complex
- Especially hard to implement TDMA part
 - How to deal with topology changes?

54

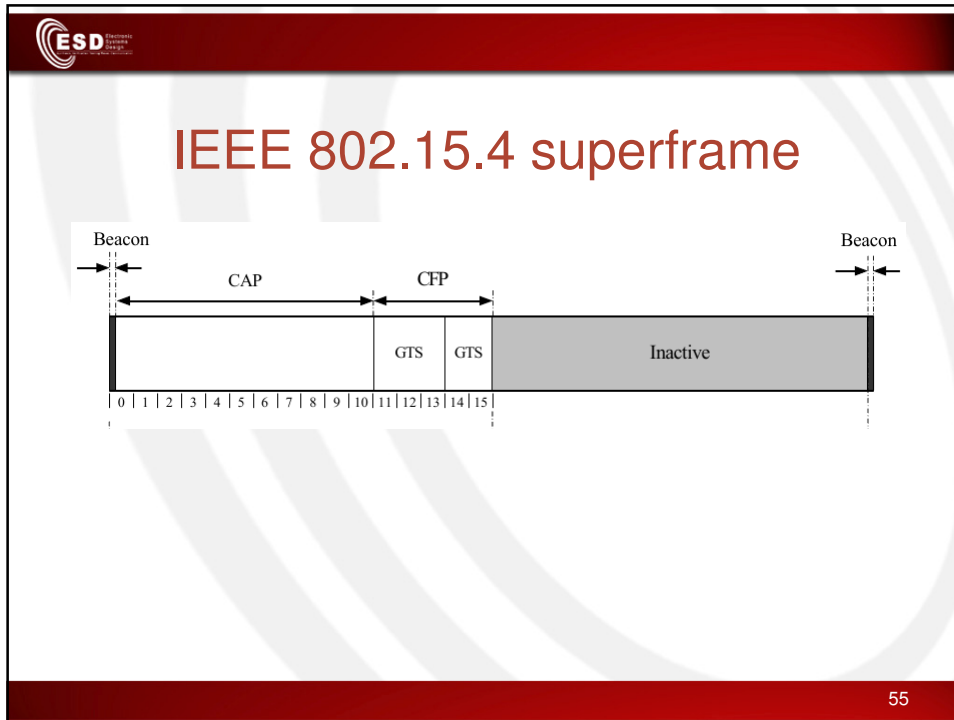

55

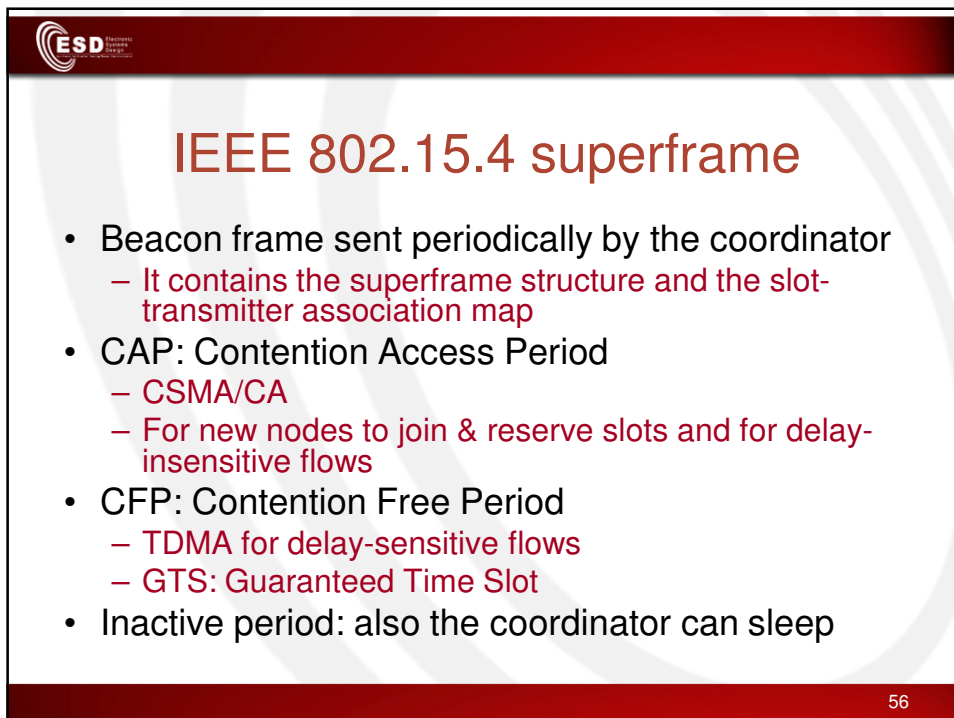

IEEE 802.15.4 superframe

- Beacon frame sent periodically by the coordinator
 - It contains the superframe structure and the slot-transmitter association map
- CAP: Contention Access Period
 - CSMA/CA
 - For new nodes to join & reserve slots and for delay-insensitive flows
- CFP: Contention Free Period
 - TDMA for delay-sensitive flows
 - GTS: Guaranteed Time Slot
- Inactive period: also the coordinator can sleep

56



MAC protocols supported by TinyOS

- CC1100: experimental B-MAC
- CC2420: X-MAC