



Wireless Sensor Networks

Davide Quaglia

*based on slides
by Seapahn Megerian and Damiano Carra*



What are sensor networks?

- Small, wireless, battery-powered sensors

Smart Dust

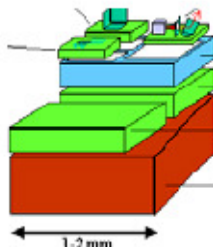

iMote2





Architecture

- CPU (also called micro-controller unit - MCU)
- Memory
 - Static and dynamic memory to store volatile data
 - Flash memory to store persistent data
- A/D converter and digital I/O
- Sensors (e.g., temperature, humidity, light, motion, etc.)
- Actuators
- Radio transmitter/receiver (transceiver)
- CPU, memory, A/D are usually in the same chip
- Antenna
- Battery or energy harvesting (collector)
- Packaging for harsh environment

3



Architecture (2)

- Sensors and radio may be either in separate chips or in a single System on Chip
- Actuators are always separated components

4



Example: iMote2

- Several chips on a board
 - Intel PXA271 Xscale processor
 - From 13 to 416MHz
 - Wireless MMX DSP Coprocessor
 - 32MB Flash
 - 32MB SDRAM
 - Texas Instruments CC2420 to provide IEEE 802.15.4 radio (2.4GHz radio band)
 - Application Specific I/O
 - I2S, AC97, Camera Chip Interface, JTAG

5



Example: iMote2

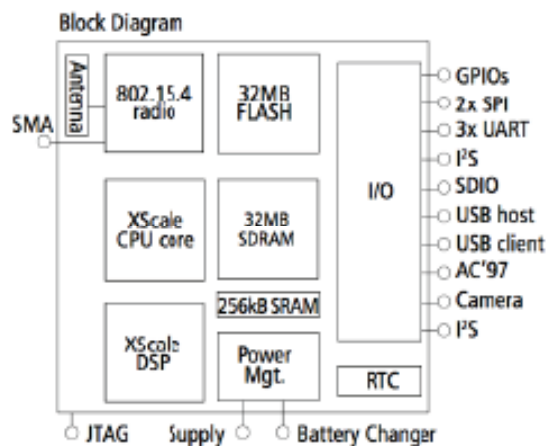

6



Example: Texas Instruments CC2530

- Single system on chip
 - CPU + memory + encryption co-processor + radio + timer + temperature sensor
- Together with an antenna and a power source it represents a complete WSN node

7



Example: Texas Instruments CC2530

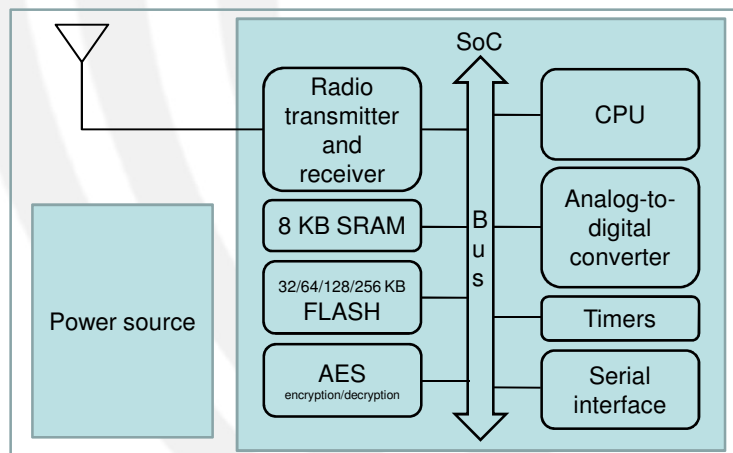

8



Why small, wireless, battery-powered sensors?

- Traditional big, wired sensors
 - Expensive, inefficient, hard to deploy, power-consuming
 - Undesirable: For example, deployment of big traditional sensors can disturb the environment in habitat monitoring
 - Dangerous: Imagine manual deployment of big traditional sensors for disaster recovery

9



Why small, wireless, battery-powered sensors?



10



WSN Applications

- Inexpensive micro-sensors & on-board processing embedded in environments for fine-grained in-situ monitoring
- Ad-hoc deployment – No communication infrastructure should be built ahead of time

Structural Monitoring Fire monitoring

Golden Gate Bridge



Habitat monitoring



11



WSN Applications: healthcare

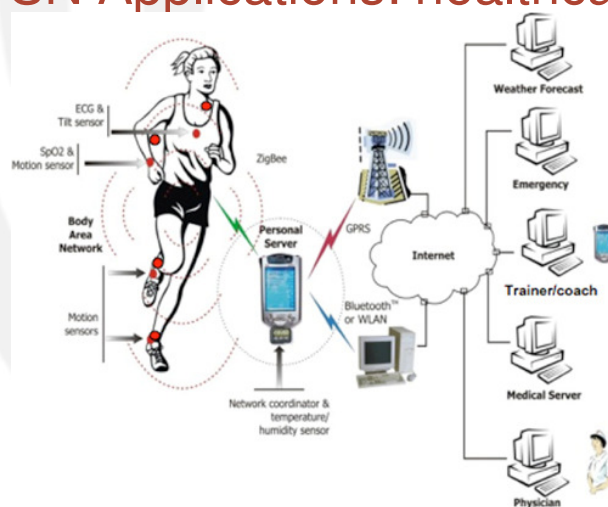

12

ESD Elements Energy Design

WSN Applications: agriculture

Sensors



Ethylene Soil Moisture Thermistor

Actuators



Irrigation Lamps

13

ESD Elements Energy Design

WSN Applications: home automation



Temp Sensor (indoor/outdoor)

Lights

Automated Blinds

Thermostat

Light Switch

Home Theatre

SmartRemote

14



WSN Applications: management of power/gas/water infrastructure

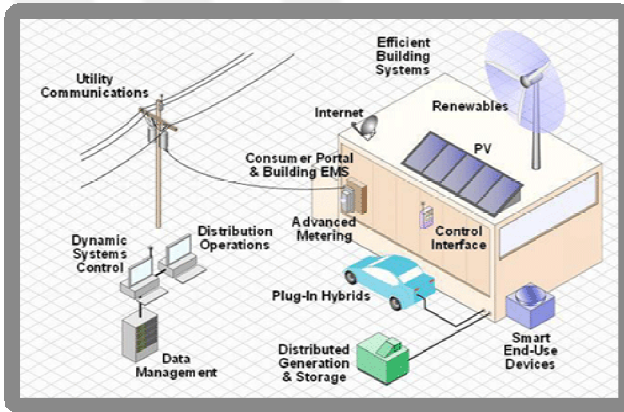

15



WSN Applications: logistics



16



Applications

- Interface between Physical and Digital Worlds
 - **Cyber-Physical Systems**
- Industry: industrial monitoring, fault-detection...
- Civilian: traffic, medical...
- Scientific: eco-monitoring, seismic sensors, plume tracking...

17



Objective

- Large-scale, fine-grained, heterogeneous sensing
 - 100s to 1000s of nodes providing high resolution
 - Spaced a few feet to 10s of meters apart
 - In-situ sensing
 - Heterogeneous sensors

18



Properties

- **Wireless**
 - Easy to deploy without wiring and digging
 - Transmitting 1 bit consumes the same energy as executing 1000 instructions
- **Distributed, multi-hop**
 - Closer to phenomena
 - Improved opportunity for line-of-sight
 - Radio signal is proportional to $1/r^4$
 - Less energy transmitting N times on a small distance than once with a higher distance
 - Centralized approach do not scale
 - Multiple data path from sources to destination
- **Collaborative**
 - Each sensor has a limited view in terms of location and sensor type
 - Sensors are battery powered or they harvest energy from environment
 - In-network processing to reduce the amount of transmitted data

19



Basic Terminology and Concepts

- **Phenomenon:** Physical entity being monitored
- **Sink or base station or gateway:** a collection point to which the sensor data is sent
 - Relatively resource-rich node
 - Connection to the “normal” network and Internet
- **Sensor network periodically samples phenomena in space and time**
- **Two possible operations:**
 - Data are sent to the sink periodically
 - The sink can send queries

20

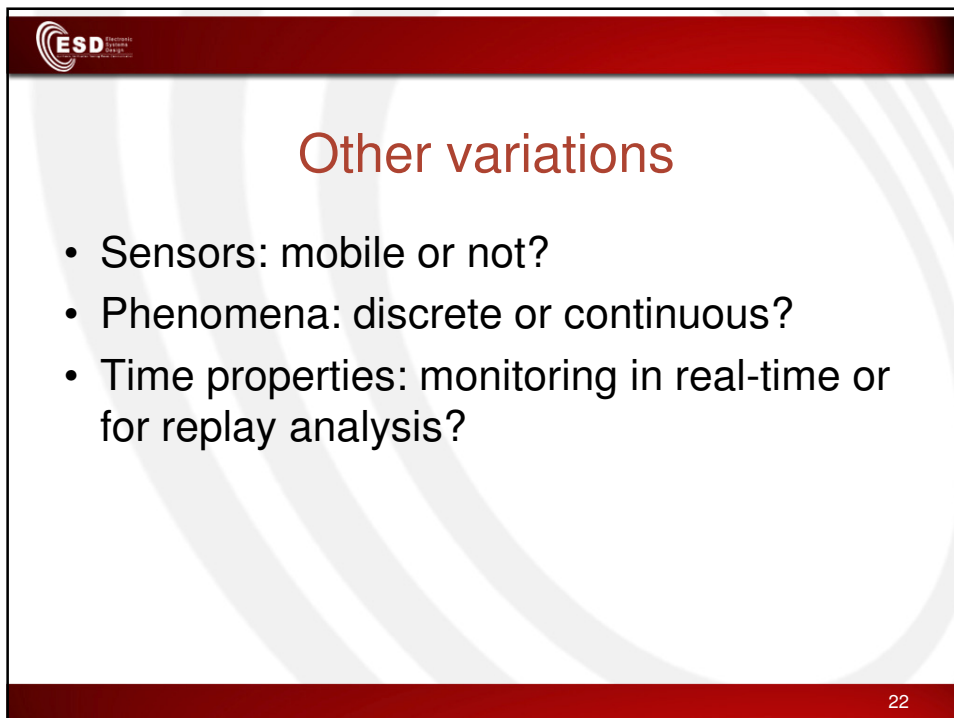
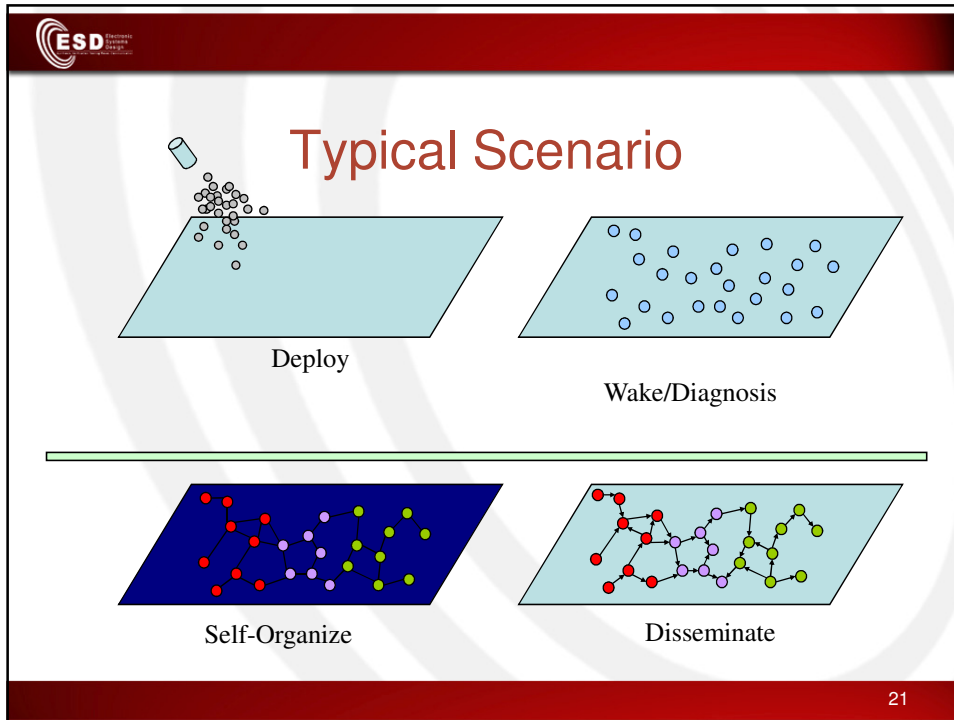

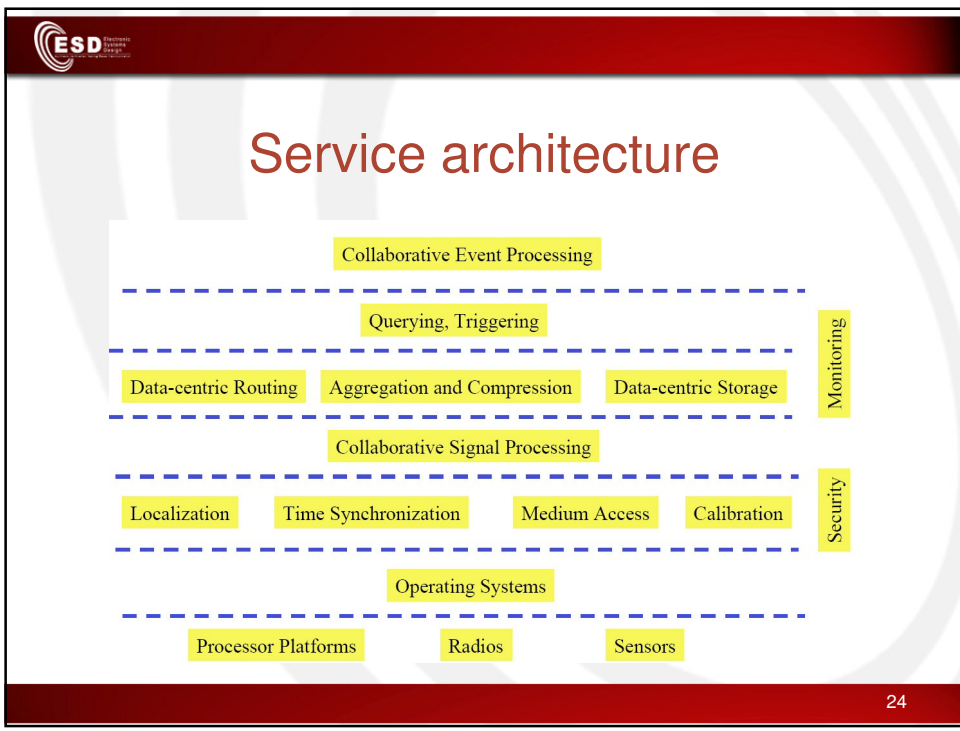
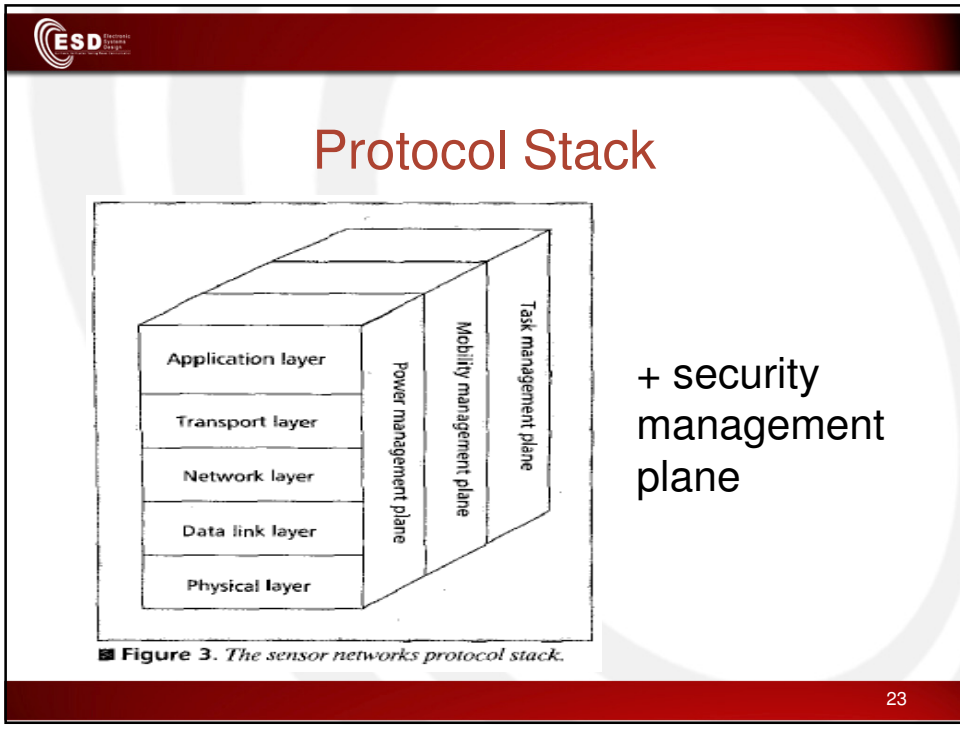



Protocol Stack: Physical Layer

- Frequency selection
- Carrier frequency generation
- Signal detection
- Modulation

- Not the focus of this class
 - We will focus on the link layer and above

25



Protocol Stack: Physical Layer

- Issues
 - Hardware cost
 - How do we get down to \$1/node?
 - Example
 - IEEE 802.15.4
 - 2.4GHz radio band (= WiFi & Bluetooth) or 868/915 MHz radio band
 - 250 kb/s
 - Channel access mode: CSMA/CA (= WiFi)

26



Protocol Stack: Data Link Layer

- PDU detection
- Point-to-point transmission
- Creation of the network infrastructure
- Addressing
- Medium access control
- Error detection
- Ack and retransmission

27



Data Link Layer: Medium Access Control

- Basic strategy:
 - Only one RF interface per node (RX vs. TX)
 - Turn off RF interface as much as possible between receiving and transmitting intervals to save power
- Techniques: Application-layer transmission scheduling, TDMA, SMAC, ZMAC, BMAC, ...

28



Protocol Stack: Network Layer

- Main goals:
 - addressing
 - Routing
 - Multi-hop forwarding
- Design principles:
 - Power efficiency
 - Data-centric instead of address-centric
 - Data aggregation when desired and possible

29



Multi-hop transmission

- Needed to avoid high power transmission thus saving power
- No fixed rules
 - Sensors/actuators can be also routers



30



Design aspects for routing

- Maximum power available route
- Minimum energy route
- Minimum hop (MH) route
- Simple tree to avoid computational complexity
- In general flooding is too energy demanding

31



Example: Directed Diffusion

- One of the first data-centric routing protocols
- Route based on data types and interests
- How it works:
 - Sink floods interest on some data types
 - Sensors send data toward the sink
 - Sink add/reinforces node/data_type association

32



Protocol Stack: Application Layer

- Actual WSN applications
- Sensor database
 - TinyDB
 - Cougar
- Virtual machines
- Middleware

33



Protocol Stack: Transport Layer

- Application multiplexing
- Application discovery
- End-to-end security
 - Like SSL: authentication, encryption, data integrity
 - Feasible? What about data aggregation?

34



Other Important Issues

- Operating system
 - TinyOS: Event-driven
 - FreeRTOS
 - MANTIS OS, LiteOS, etc: Multithreaded
- Localization, Timing Synchronization, and Calibration
- Aggregation/Data Fusion
- Security
 - Encryption
 - Authentication
 - Data integrity
 - Availability: denial-of-service attacks

35



Time and Space Problems

- Timing synchronization
- Node Localization
- Sensor Coverage

36



Time Synchronization

- Time sync is critical at many layers in sensor nets
 - Object detection, data aggregation, localization, medium access control

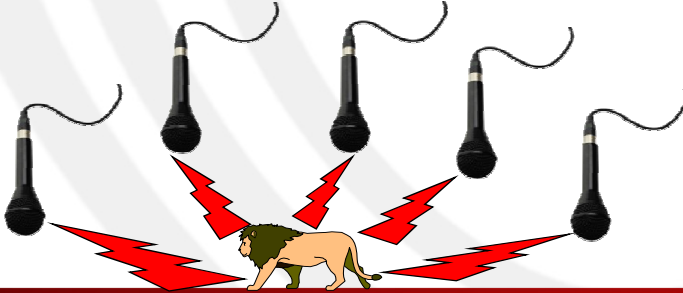

37



Sources of time synchronization errors

- Send/receive time
 - OS processing
 - Interrupt latency
 - Context switches
 - Transfer from host to network interface
- Medium access time
 - Depending on the MAC protocol
 - E.g. in CSMA/CA, sender must wait for free channel
- Propagation time
 - Function of the number of hops
- Drift of the clock circuitry

38



Conventional Approaches

- GPS at every node (around 10ns accuracy)
 - Doesn't work indoor
 - Cost, size, and energy issues
- Network Time Protocol
 - Primary time servers are synchronized through atomic clock
 - Pre-defined server hierarchy
 - Nodes synchronize with one server of a pre-specified set
 - Support for coarse-grain time synchronization but inefficient when fine-grain sync is required (localization, time-division multiple access - TDMA)
 - Discovery of time servers
 - Potentially long and varying paths to time-servers
 - Delay and jitter due to MAC and store-and-forward relaying

39



Localization

- Why each node should find its location?
 - Data meaningless without context (e.g. RF tag for asset tracking)
 - Support to commissioning (=configuration)
 - Geographical forwarding/addressing (less important)
- Why not just GPS at every node?
 - Large size and expensive
 - High power consumption (it is a receiver)
 - Works only outdoors with line of sight to satellites
 - More than needed: often only relative position is needed

40



What is Location?

- Absolute position on geoids
- Location relative to fixed anchor points
- Location relative to other WSN nodes
- Specific area inside a set of possible areas
- Most applications:
 - location relative to other people or objects, whether moving or stationary, or room number within a building

41



Techniques for Localization

- Measure proximity to anchor points
 - Near a base station in a room
 - Active badge for indoor localization
 - Infrared base stations in every room
 - Localizes to a room as room walls act as barriers
 - Most commercial RF ID Tag systems
 - Strategically tag readers are located at gates
 - Beacon grid for outdoor localization
 - Grid of outdoor beaconing nodes with know position
 - Position = solution of a geometric problem
 - Problem
 - Accuracy of location is a function of the density of beacons

42

ESD Elements of Systems Design

Localization: direction based

- Measure direction of landmarks
 - Simple geometric relationships can be used to determine the location by finding the intersections of the lines-of-position
 - e.g. Radiolocation based on **angle of arrival (AoA)**
 - can be done using directional antennas or antenna arrays
 - need at least two measurements

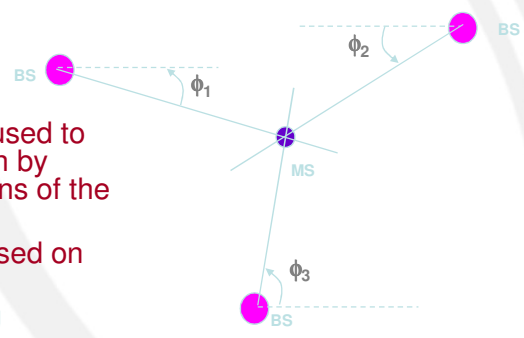

43

ESD Elements of Systems Design

Localization: Range-based

- Measure distance to anchor points
 - Measure: **signal strength** or **time-of-arrival**
 - Estimate distance via received signal strength
 - Mathematical model that describes the path attenuation with distance
 - Use pre-measured signal strength contours around fixed beacon nodes
 - Distance via Time-of-arrival (ToA)
 - Distance measured by the propagation delay
 - Distance = time * c
 - N+1 anchor points give N+1 distance measurements to locate in N dimensions

44



Many other issues

- Localization in presence of transmission errors
- Beacon signal is too weak
- Localization frequency in case of mobile nodes

45



Sensor Network Coverage

- Given:
 - Ad hoc sensor field with some number of nodes with known location
 - Start and end positions of an agent
- How well can the field be observed?

46

ESD

Data Management Problems

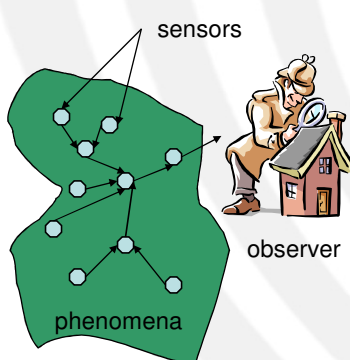

- Observer interested in phenomena with certain tolerance
 - Accuracy, freshness, delay
- Sensors sample the phenomena
- Sensor Data Management
 - Determining spatio-temporal sampling schedule
 - Difficult to determine locally
 - Data aggregation and fusion
 - Interaction with routing
 - Network/Resource limitations
 - Congestion management
 - Load balancing
 - QoS/Real-time scheduling

47

ESD

Key Design Challenges

- Energy efficiency
 - Sensor nodes should run for several years without battery replacement
- Energy efficient protocols and low-power SoC are required
- More efficient batteries
 - But, efficient battery evolution is always slower than processor/memory/network evolution
- Energy harvesting instead of or combined to batteries
 - Solar cells
 - Energy from vibrations (piezoelectric effect)
 - Energy from temperature differences
 - Energy from mechanical actions (e.g., sensors in shoes)
 - ... any new idea ?

48



Key Design Challenges

- Responsiveness
 - Crucial in real-time applications
 - Periodic sleep & wake-up can reduce the responsiveness of sensors and the data rate
 - Important events could be missed
 - Transmission could be delayed
 - Network congestion can increase the access time in CSMA MAC and the delay spent in queues

49



Key Design Challenges

- Robustness
 - Inexpensive sensors deployed in a harsh physical environment could be unreliable
 - Some sensor could be faulty or broken
 - Global performance should not be sensitive to individual sensor failures
 - Graceful performance degradation is desired when there are faulty sensors

50



Key Design Challenges

- Synergy
 - Moore's law applies differently
 - More powerful sensors may not be required
 - Cost reduction is the key to a large number of sensor deployment
 - A WSN as a whole needs to be much more capable than a simple sum of the capabilities of the sensors
 - Exploit contextual information to send meaningful information rather than raw data
 - Sharing of computation, communication, and storage resources

51



Key Design Challenges

- Scalability
 - 10000 or more nodes for fine-granularity sensing & large coverage area
 - Distributed, localized communication
 - Hierarchical structure
 - Address fundamental problems first
 - Failure handling
 - In-situ reprogramming
 - Network throughput & capacity limits?

52



Key Design Challenges

- Heterogeneity
 - Heterogeneous sensing, computation, and communication capabilities
 - e.g., a small number of devices of higher computational capabilities & a large number of low capability nodes -> two-tier WSN architecture
 - Best architecture exist for all application?
NO!!!
 - How to determine the right combination of heterogeneous devices for a given application?

53



Key Design Challenges

- Self-configuration
 - WSNs are unattended distributed systems
 - Nodes have to configure their own network topology
 - Localize, synchronize & calibrate
 - Coordinate communications for themselves
 - The network should repair itself in case of node failures

54



Key Design Challenges

- Self-optimization & adaptation
 - WSN cannot be optimized a priori
 - Environment is unpredictable, and may change drastically
 - WSN protocols should be adaptive & should adapt themselves at run-time

55



Key Design Challenges

- Design methodologies
 - Tradeoff between two alternatives
 - (1) Fine-tuning to exploit application specific characteristics to improve performance
 - (2) More flexible, easy-to-generalize design approaches sacrificing some performance
 - Design methodologies for reuse, modularity & run-time adaptation are required

56



Key Design Challenges

- Security & Privacy
 - Security support to avoid actions and data replacement
 - e.g., remote control of plants
 - Support privacy to protect data
 - e. g., medical sensing, asset tracking